

ElektroPhysik

Technical Manual /Operating Instructions

Thickness Gauge

MiniTest FH



© Edition 01, 04/2024

Valid for min gauge software version 1.6 and sensor software version 1.15

Subject to technical changes without notice
ElektroPhysik Dr. Steingroever GmbH & Co. KG
Pasteurstr. 15; D-50735 Cologne, Germany

Tel.: +49 221 752040

Fax.: +49 221 7520467

<http://www.elektrophysik.com/>

info@elektrophysik.com

1. Introduction	9
2. First Steps	10
2.2 Switch ON and Take Readings	11
2.2.1 Language setting	11
3. Description of the measuring system	13
3.1 Basic unit	13
3.1.1 General Remarks.....	13
3.1.2 Operating keys	13
3.1.3 Connections and interfaces	14
3.1.4 Power supply	15
3.1.4.1 Battery operation	15
3.1.4.2 Mains operation	15
3.2 Sensors	15
3.2.1 General Remarks.....	15
3.2.2 Sensor Models.....	16
3.2.3 Replacing the wear cap on sensor types FH4cc, FH4cc-90 and FH10cc.....	18
3.2.4 Sensor Stand.....	19
4. Working with the user interface	20
4.1 General Remarks	20
4.2 Switch-ON / Start Screen	20
After approx. 2 seconds the gauge switches to the measure screen of the last batch that was active before the gauge was switched off	20
4.3 Measuring screen /Statistics screens	20
4.3.1 Measuring mode –Screen with numerical display and statistics	20
4.3.2 Measuring mode – Screen with numerical display	21
4.3.3 Measuring mode – Graphical screen showing online trend	21
4.3.4 Measuring mode – Screen with numerical display in setpoint mode.....	22
4.3.5 Statistical screens.....	22
4.4 Display symbols	23
4.4.1	23
4.4.2	23
4.4.3	23
4.5 Navigation in the menu system	24

4.6	Parameter setting	25
4.6.1	Setting switching parameters (Example: Speakers)	25
4.6.2	Setting selection parameters (Example: Language)	25
4.6.3	Setting numerical parameters (Example: Upper limit)	26
4.6.4	Setting alphanumerical parameters (Example: Folder name).....	27
5.	Measure Mode.....	28
5.1	Important Notes on Thickness Measurement.....	28
5.1.1	Limitations to magneto-static thickness measurement	28
5.2	Batch Configuration / Necessary Settings.....	28
5.2.1	Batch	28
5.2.2	Target Ball Size	29
5.2.3	Data Logging Mode	29
5.3	Preparing Measurement.....	29
5.3.1	Calibration	30
5.3.2	Measurement without Sensor Stand	30
5.3.3	Using the Sensor Stand	30
5.4	Take Readings	31
5.4.1	Measuring without sensor stand	31
5.4.2	Measuring using the sensor stand	31
5.4.3	Delete Readings	31
5.5	Storing Readings into Statistics Memory	32
5.5.1	Data Logging Mode	32
5.5.2	Manual Data Storage.....	32
5.5.3	Automatic Data Storage (Auto).....	32
5.5.4	Storing Minimum Reading.....	33
5.5.5	Storing Maximum Reading.....	33
5.6	Error Sources during Measurement.....	33
5.6.1	Correct Sensor Position	34
5.6.2	Incorrect Readings through tilting of the Sensor.....	34
5.6.3	Incorrect readings through Blocked Target Ball.....	34
5.6.4	Air Gap.....	35
5.6.5	Measuring material with ferruginous particles	35
5.6.6	Influencing magnetic fields through environmental influences.....	35
5.6.7	Influence of the surface quality (roughness, cleanliness) of the test material on the measurement.....	35

5.6.9	Measurement using magnetized steel balls	36
5.6.10	Measurement using steel wires.....	36
5.6.11	Sensor alignment.....	37
6.	Calibration.....	37
6.1	General Remarks on Calibration	39
6.2	Calibration methods	40
6.3	How to calibrate.....	40
6.3.1	Factory Calibration	41
6.3.2	Quick calibration	41
6.3.3	Zero (point) calibration	41
6.3.4	Multi-point calibration (Zero + 1 to 4 point(s)).....	42
6.5.	Deactivate or delete calibration point	43
6.6.	Calibration Error Sources	45
7.	Data Storage.....	46
7.1	Batches	46
7.1.1	General.....	46
7.1.2	Batch Data	46
7.1.2.1	Readings.....	46
7.1.2.2	Calibration Values	46
7.1.2.3	Other parameters	46
7.2	Database of the MiniTest FH.....	47
7.2.1	General Remarks	47
7.2.2	Tree structure.....	47
7.2.3	Create folders	47
7.2.4	Create a New Batch	48
7.2.5	Select a Batch for Measurement	48
7.2.6	Delete a batch / folder	48
7.2.7	Rename a Batch / Rename a folder	49
8.	Statistics.....	50
8.1	Statistical Parameters	50
8.1.1	Upper and lower specifications limits (USL and LSL)	50
	Spec. limits can be deleted via the function key "Delete".....	50
	Spec. limits can be set before or after readings have been taken.	50
8.1.2	Set Point (Differential Mode)	51

8.2 Readings	51
8.2.1 View Readings	51
8.2.2 Suppress individual readings	51
8.2.3 Delete all readings	52
8.3 Numerical statistics	52
8.4 Histogram on MiniTest FH	53
8.5 Trend Diagram on MiniTest FH	54
9. Data output / Data transfer	55
9.1 Data print-out	55
9.1.1 Creating a screen shot.....	56
9.1.2 Print-out a Batch	56
9.2 Transfer data to a PC	56
9.3 Read out data via USB	58
10. Main Menu	59
10.1 Database	59
10.2 Batch configuration	59
10.3 Gauge configuration	60
10.3.1 Display brightness	60
10.3.2 Speaker	60
10.3.3 Language.....	61
10.3.4 Time/Date	61
10.3.5 Display unit.....	61
10.3.6 Auto power off	62
10.3.7 Change lock.....	62
10.4 Sensor configuration	62
10.5 Interfaces	64
10.6 Data output	66
10.6.1 Data storage	66
10.6.2 Data output on...	67
10.6.2.1 Data output: Setting "USB"	67
10.6.2.2 Data output: Setting "RS-232".....	67
10.6.2.3 Data output: Setting "Bluetooth"	68
10.6.2.4 Data output: Setting "Bluetooth printer"	68

10.6.2.5	Setting data format: Unit, Decimal separator, Data block limiter, Number of measuring value, Time stamp.....	68
10.7.	Identification data.....	70
11.	Service functions.....	71
11.1	Gauge service menu.....	71
11.2	Total-Reset (Resetting to the factory settings.....	71
11.2).....	71
11.	Updating gauge firmware.....	72
12.	Connectable accessories.....	74
12.1	General remarks.....	74
12.2	Direct connection.....	74
13.	Care and Maintenance.....	75
13.1	Care.....	75
13.1.1	Using NiMH storage batteries.....	75
13.2	Maintenance.....	76
14.	Technical specifications.....	77
14.1	Gauge and Sensor Specifications.....	77
14.2	Delivery Scope.....	79
14.2.1	Wall thickness gauge MiniTest FH.....	79
14.2.2	Sensors.....	80
14.3	Accessories.....	81
15.	Appendix.....	84
15.1	Troubleshooting.....	84
15.2	Possible interferences affecting the measuring process.....	86
15.3	Statistical Terms.....	87
15.4	Safety Notes.....	88
15.5	Declaration of Conformity.....	91
15.6	Return of old equipment.....	91
15.7	After-Sales service.....	92
16.	Index.....	93

1. Introduction

Designed for non-destructive thickness measurement, the portable MiniTest FH measuring systems are suitable for in the field or laboratory use. Working on the magneto-static principle, the gauges enable quick and easy measurement on non-ferromagnetic materials.

The measuring system consists of a handy sensor, which is connected via a cable to the base and display unit for visualization and processing of readings. For measurement, specially treated target balls or wires made of a ferromagnetic material are used as a reference. For measurement, a target ball is placed on the material to be measured in order to measure the material thickness between target ball and sensor. The measuring system comes with sensor stand to add additional comfort of handling during measurement.

For documentation the gauge can be connected to a PC via USB, RS or Bluetooth interface.

For taking readings, the sensor is placed on the surface of the measuring object, the target ball is placed on the opposite side of sample. Equipped with a strong permanent magnet, the sensor attracts the target ball and holds it exactly over its sensor tip. When moving the sensor, the target follows accordingly. The presence of the target ball will change the magnetic field near the sensor tip. The magnetic field changes according to the distance between target ball and sensor tip. The change of magnetic field increases with the distance between target ball and sensor tip getting smaller and can be taken as a reference for the material thickness of the sample to be measured. The sensor incorporates a Hall element to capture the change of magnetic field and to translate it into thickness.

To measure hollow parts, a target ball is placed into the interior of sample and the sensor is placed on the opposite side in order to attract the target ball exactly over the sensor tip. For taking readings, the sensor is moved over the surface of sample. For measurement of sheets, the sensor is placed on the surface of sheet and the target ball is placed near the sensor on the opposite side of sheet. The target ball will automatically find the correct measuring position and the measuring processes can be started.

For measuring large-sized parts, the sensor can be guided manually over the sample to be measured. For measuring small parts, it is recommended to use the measuring stand supplied with the sensor.

The MiniTest FH measuring system is used in the industrial production of hollow bodies and containers of all kinds such as bottles, cups, cans, but also injection molded parts, car body parts, glass panes, composite materials etc. made of non-magnetic (non-ferritic) materials.

2. First Steps

This section refers to persons using the gauge for the first time and explains the main features of the gauge and how to take readings.

- a) Upon initial start-up after delivery, the batteries are not fully charged. Charge the batteries before using the unit for the first time. Connect the USB cable to the  USB socket and plug the mains adapter into a mains socket.

Exclusively use the USB cable and adaptor that are supplied with the gauge. The batteries are charged both when the device is switched on and off.

- b) Take the sensor (or the sensor best suited to the application if you have more than one sensor) out of the transport case and insert the plug into the sensor socket on the top of the MiniTest (see illustration). Ensure that the "nose" of the plug is positioned in the guide groove of the socket. The red dot on the sensor plug must point towards the red dot on the sensor socket.
- c) Push the plug into the socket until it locks firmly. If necessary, remove the plug from the socket by pulling on the outer unlocking sleeve. Do not pull at the cable.

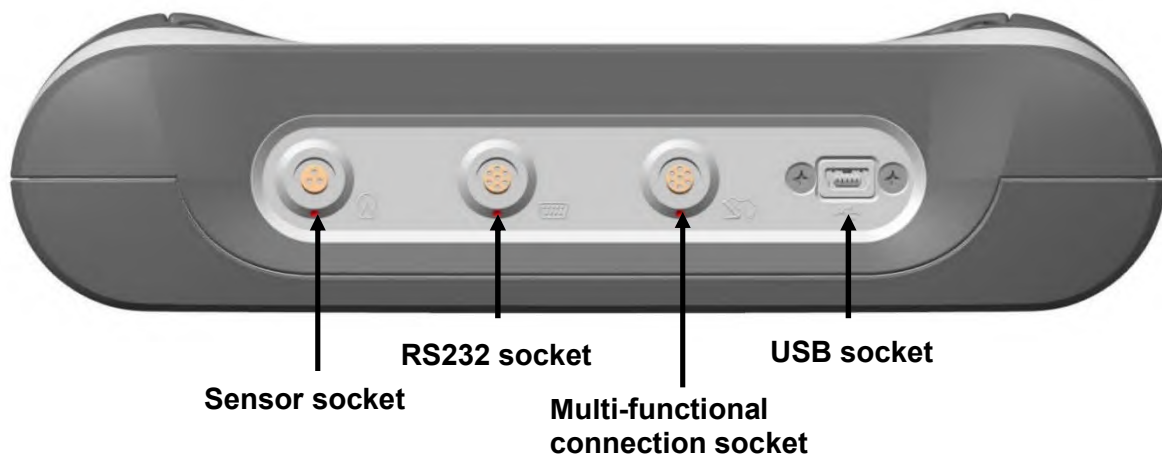

MiniTest FH is equipped with two mounting brackets. Grasp the set-up brackets at the ends and pull both brackets outwards until the brackets click into place.



2.2 Switch ON and Take Readings

2.2.1 Language setting

For language setting before initial start-up press the red ON-OFF button to switch on the gauge.



- The start screen appears showing safety instructions (see chapter 15.4), model name of the gauge and the version of the sensor that is connected (see illustration).
- After approx. 2 seconds, the gauge switches automatically into measure mode and is ready to take readings. The Measure Screen will appear without any reading being shown.
- Upon initial start-up, the menu language is set to English. In order to select another language, see chapter 10.3.3 “Language” under “Gauge configuration” in main menu.
- Set the format of the stored measured values before the first measurement. See chapter 10.6.1 “Data storage” under Data output in main menu.
- This setting can only be carried out as long as no measuring values have been recorded in the data memory.
- The gauge is factory set to measuring in “Direct Mode” (see chapter 7.2.2) and calibration method “Factory calibration” (For more detailed information on calibration methods, refer to chapter 6). The active calibration method as well as the active measuring batch are displayed

in the status line. . Before any measurements, verify if the active steel ball diameter is suitable for your application. (For more information on selection of the appropriate steel ball, refer to chapter 5.2.2 “Steel ball diameter“) or set the correct diameter as described in chapter 5.2.2.

- g) “Factory calibration“ is used for simple, quick measurement if larger measurement errors are also permitted. For other calibration methods, see chapter 6.3.
- h) The new MiniTest FH offers innovative quick calibration. The ball diameter is determined, and a zero-point calibration is performed in a single automated process. Hence, the accuracy is considerably increased compared to factory calibration. (see chapter 6.3.2. “Quick calibration“.

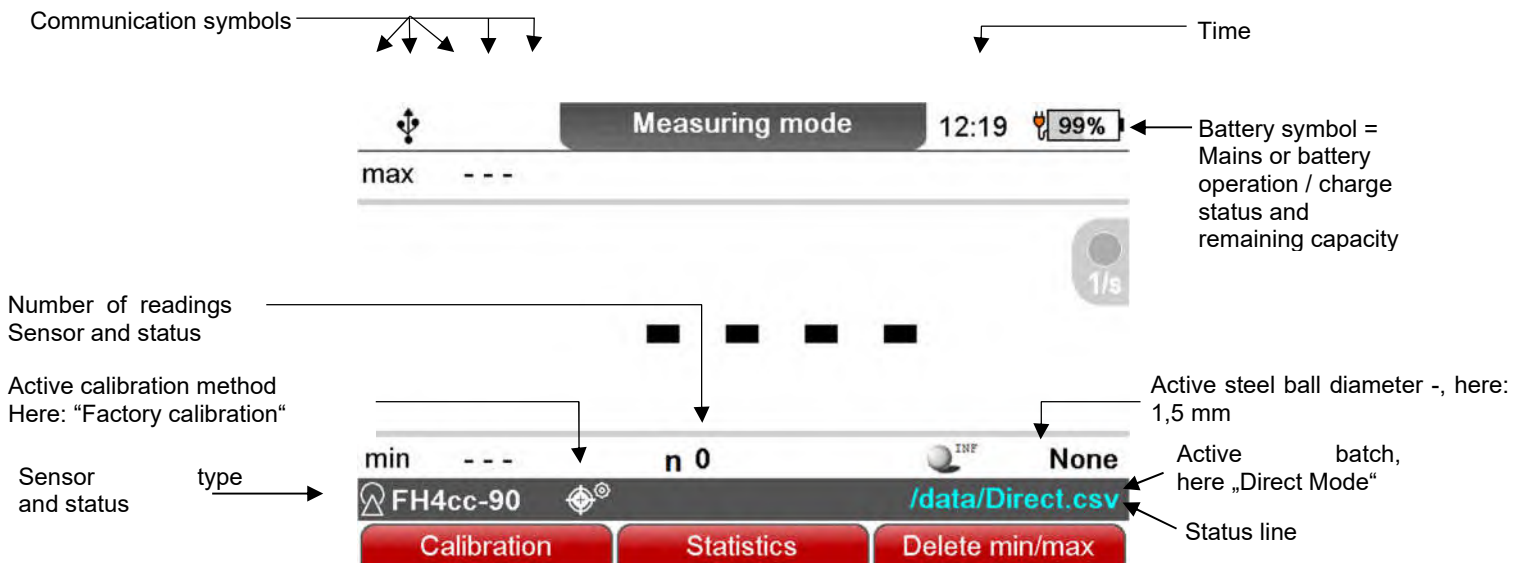

Switch on gauge using the red ON-OFF key.

- a) The MiniTest FH is now in measuring mode (see fig.) and is ready to measure. The measurement screen is displayed, but no measured value is available yet.
- b) For measurement, please use the sensor stand supplied with the gauge. Place the measuring object on the sensor. Place the target ball on the opposite side. For measuring hollow parts, place the ball inside the sample. The strong permanent magnet of the sensor attracts the target ball and holds it exactly over the sensor tip. Hold the measuring object in rectangular position to the sensor and move it smoothly over the sensor. Press OK to store the reading into memory. Press Function key “Statistics” to view readings and the numerical statistics. To measure large-sized sheets or large hollow parts, place the sensor on the surface of sample. The target ball is placed on the opposite side near the sensor. Keep the sensor in rectangular position to the surface and move it across the surface of sample.

3. Description of the measuring system

3.1 Basic unit

3.1.1 General Remarks



A large, graphic display 4.3" TFT/LCD with a resolution of 800x480 pixels enables good readability of measured values, statistical data, histogram and trend chart.

The housing is made of impact and scratch-resistant plastic with IP protection class 65.

3.1.2 Operating keys

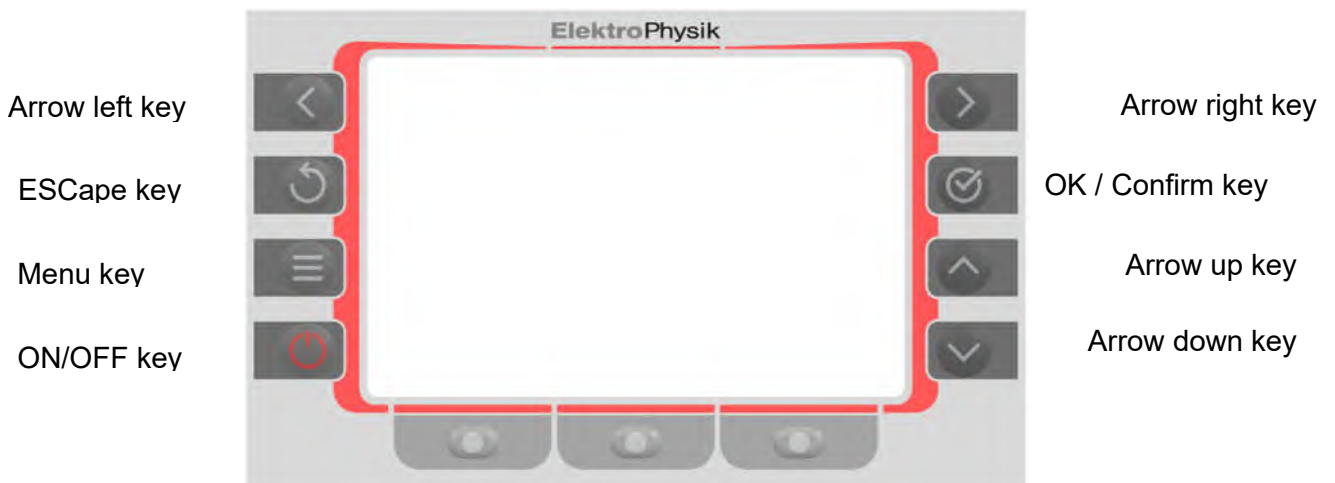



The currently activated function of the function buttons is shown on the bottom line of the display above the respective function button. They take on different functions depending on the active menu. In measuring mode, the buttons take on the following functions: Calibration - Statistics - Delete min/max



 Use the **ON/OFF key** to switch the gauge ON or OFF.



 The menu key is used to open the main menu from measurement mode or to return to the main menu from any submenu. Press and hold the menu key to produce a screen shot.

 Press **OK** to confirm settings, store values or select menu items.

 Press "ESC" to cancel actions, restore the original value or exit submenus. Once the parameter entry has been confirmed with "OK",  the function will NOT work. A long press on the ESC key  takes you directly back to measurement mode.

The arrow keys are used for navigation and to change settings.

  The "Up" and "Down" arrow keys are used for navigation in the menu and for selecting parameters in the menu items. In the alphanumeric screens, the arrow keys are also used for navigation.

  The left/right arrow keys are used to navigate and change settings. In measurement mode, they are used to switch between the measurement modes and the online trend. In the alphanumeric screens, the arrow keys are also used for navigation.

 **Function keys** are assigned differently depending on the screen content. The current properties are displayed in the screen line above the keys.

3.1.3 Connections and interfaces

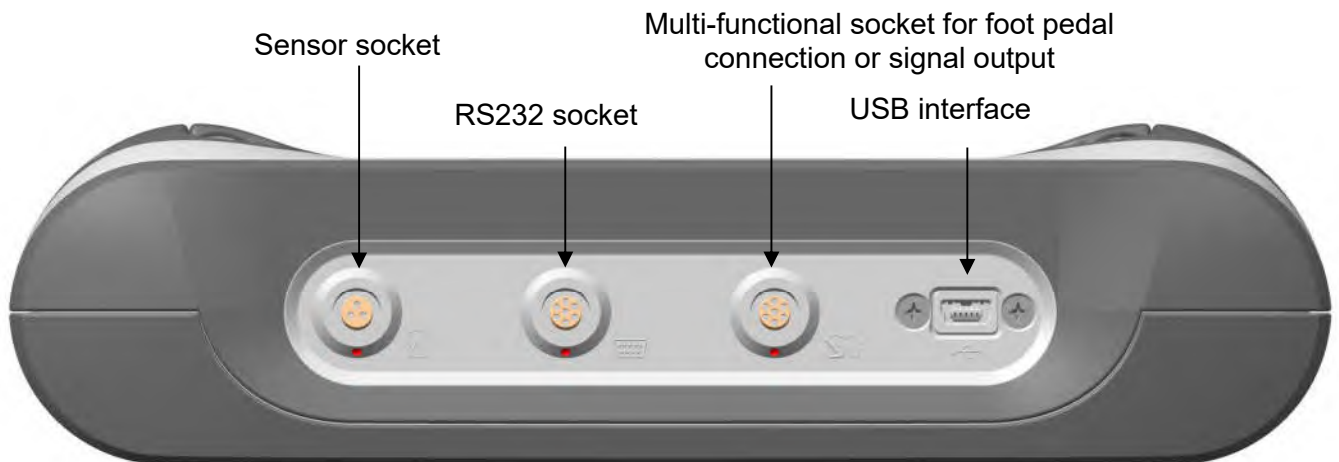

All sensor types FH2, FH4 or FH10 can be connected to the sensor socket. The RS232 socket is used to connect the RS232 adapter cable. The multifunction socket is used to connect the foot switch or alarm transmitter. The USB socket is used to connect a USB cable for measured value transmission, in conjunction with the mains adapter for mains operation and for charging the internal batteries.

The internal Bluetooth interface is used for wireless transmission of measured values from the MiniTest FH to a PC, laptop, tablet, smartphone or printer.

3.1.4 Power supply

3.1.4.1 Battery operation

Wall thickness gauge MiniTest FH is powered by a pack of rechargeable NiMH batteries 7,2V, 2700 mAh. Charge the integrated batteries exclusively using the mains adapter and the USB cable from the original delivery scope. (see chapter 14.3 Accessories).

For operation with rechargeable batteries, please refer to chapter 13 "Care and maintenance".

Note:

- - If you do not use the MiniTest FH for a longer period of time, charge the batteries before storage or recharge the batteries at regular intervals.
- The battery symbol in the display indicates the charge status of the battery pack.
- Erratic readings due to low battery voltage do not occur. If voltage is too low, the gauge switches off or does not switch on at all.
- Used or defective batteries or storage batteries may contain hazardous substances and must be disposed of according to the legal provisions of your country.

3.1.4.2 Mains operation

If you want to operate the MiniTest stationery or charge the internal battery, please use the USB plug-in power supply unit 5V/2A with the USB cable included in the scope of delivery.

The USB plug-in power supply is supplied with a socket adapter (USA standard). If the USB plug-in power supply does not correspond to your plug standard, plug the enclosed socket adapter into the USB power supply

3.2 Sensors

3.2.1 General Remarks

All FH sensors use SIDSP® technology. The innovative SIDSP® means that all necessary measuring signals are created and completely processed in the sensor itself. Only the completely processed digital readings are transferred to the base unit for display, statistical evaluation and data storage. Unlike the commonly used analog procedures, the new SIDSP procedure excludes any error influences on the measuring data during transfer over the probe cable. The result is a measuring accuracy and constancy of readings that has been unmatched so far. The complete sensor technique is integrated into a robust stainless-steel housing.

3.2.2 Sensor Models

The MiniTest FH can be equipped with various sensors.

The three sensor types FH2, FH4 and FH10 feature different measuring ranges and are each available in a straight standard version and FH2 and FH4 also in a right-angle version.

Furthermore, sensor versions with the option of extending the measuring ranges by using magnetic balls and versions with sensor tips made of hard metal or with interchangeable caps are available.

The standard sensors have an extremely wear-resistant sensor tip made of hard metal; they are also ideally suited for hard materials such as glass. They have slim tips with a small angle and small radius FH4 = 1.25 mm at 60° and are therefore particularly suitable for measurements in grooves and recesses. Due to the low wear, the precision of the factory calibration is maintained for a long time.

The interchangeable caps are subject to greater wear due to their less hard material. This has a direct influence on the measuring accuracy. A more frequent check of the calibration against the precision standards is recommended. Damaged, dented or worn interchangeable caps should be replaced at an early stage. The interchangeable caps have a larger angle and larger radius FH4cc = 1.7 mm at 110° compared to the standard version.

- FH2 0...2,3 mm
- FH2_M 0...4,5 mm using magnetic target balls
- FH4 0...6 mm
- FH4_M 0...9 mm using magnetic target balls
- FH4_1 0...6 mm additional option to measure with a Ø 1mm steel ball
- FH10 0...10 mm (Ø 6.0 mm target ball).
0...13 mm (Ø 9.0 mm target ball).
- FH10_M 0...24 mm using magnetic target balls

Note!

Measuring with magnetic steel balls requires increased diligence (see 5.6.6 “Measuring with magnetic steel balls”).

Keep ferromagnetic objects such as tools away from the sensor. Ferromagnetic metal parts can be attracted by the static magnetic field of the sensor. The impact of the metal parts on the sensor pole can cause the hard metal cap to splinter or lead to deformations of the interchangeable cap. The carbide cap is made of tungsten carbide and offers a high level of wear protection. However, tungsten carbides are brittle and can break under hard impacts.

The sensor should also not be used to pick up the measuring ball through magnetic attraction, e.g. from a container. A measuring ball accelerated by the magnetic force of attraction can damage the hard metal cap if the ball hits the sensor tip.

Make sure that the sensor is stored in the protective tube when not in use.

Do not place the sensor on a table, but place it in the supplied sensor stand when not in use. Be careful not to drop the sensor.

Sensor type FH2 & FH2-90

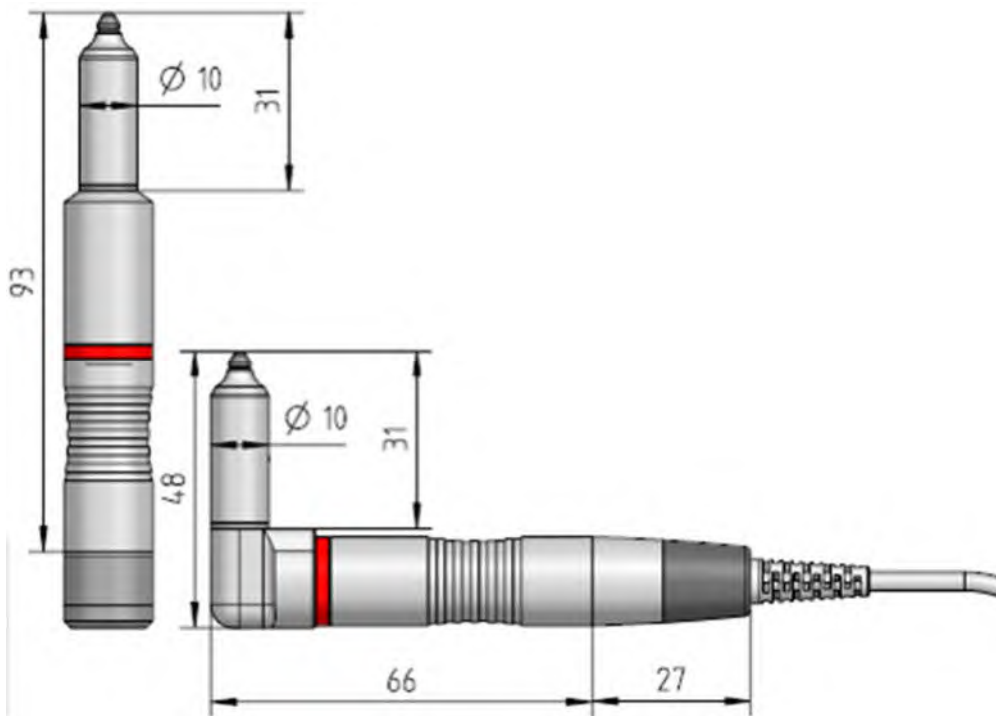

Sensor type FH4 & FH4-90

Sensor type FH4cc & FH4cc-90

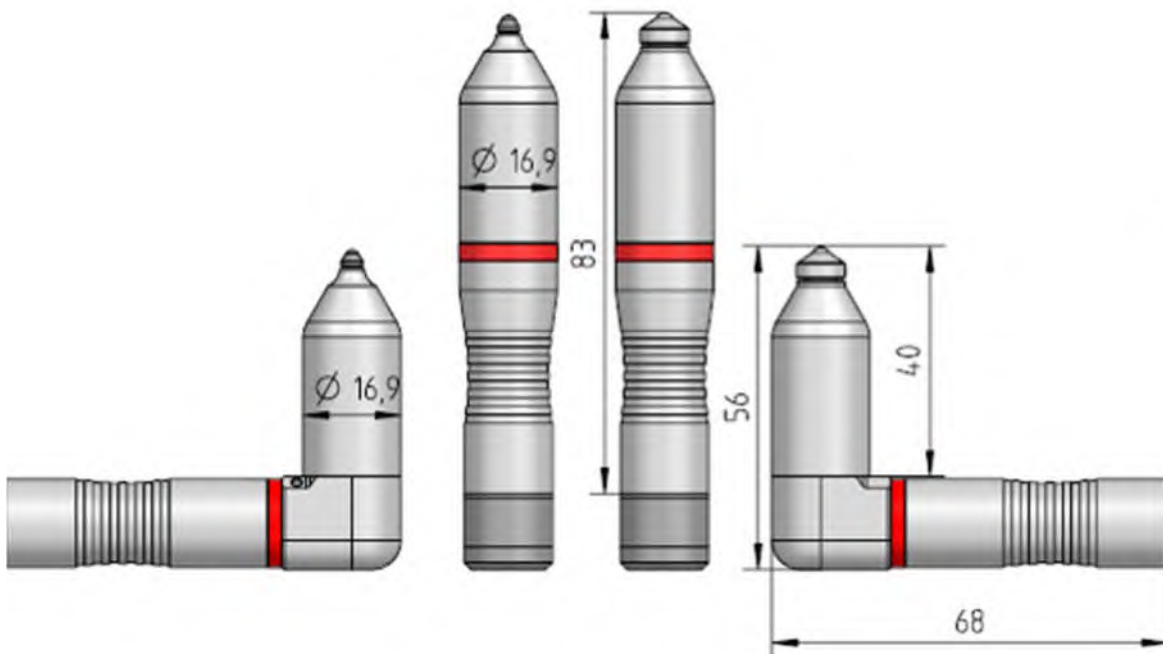

Sensor type FH10 Sensor type FH10cc

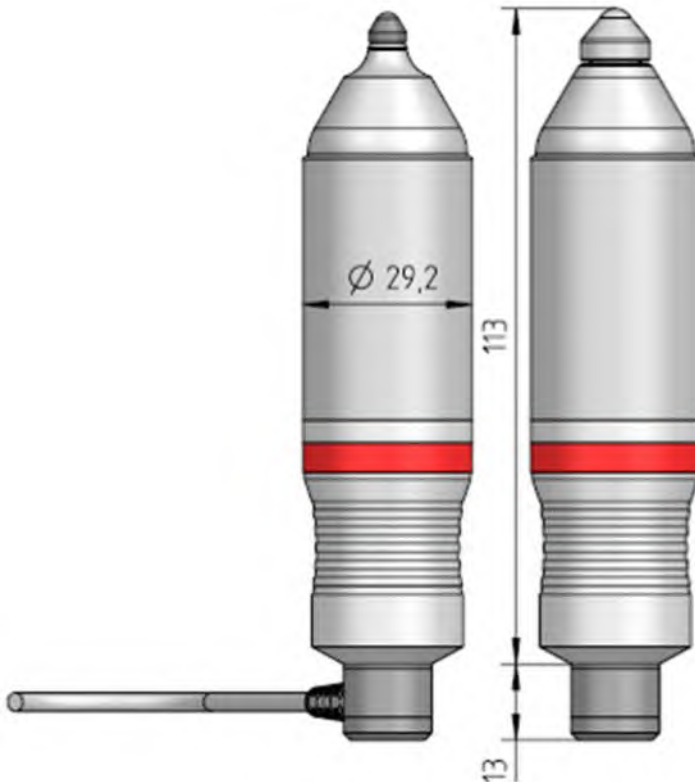

3.2.3 Replacing the wear cap on sensor types FH4cc, FH4cc-90 and FH10cc

Unscrew the wear cap on the sensor head in the grooved area anti-clockwise, replace it with a new wear cap and screw it back on clockwise. After removal or replacement, the MiniTest must be recalibrated with the sensor. Recalibration is also recommended if the wear cap has been tightened or loosened.

Note: Never use the sensor without the wear cap.



3.2.4 Sensor Stand

Standard sensor types FH2, FH 4 and FH 10 come with a spring-loaded V-grooved sensor stand whereas the right-angle sensors feature a solid sensor support. The use of the sensor stand ensures increased reproducibility of readings by adding stability of the sensor during measurement so that even small parts can be measured without problems.

4. Working with the user interface

4.1 General Remarks

4.2 Switch-ON / Start Screen

At switch on, the company logo, gauge version and type of sensor being connected are displayed.



After approx. 2 seconds the gauge switches to the measure screen of the last batch that was active before the gauge was switched off.

4.3 Measuring screen /Statistics screens

Three different illustrations are available for measuring mode: numerical with or without statistical values or graphical..

4.3.1 Measuring mode –Screen with numerical display and statistics

Communication symbols

11:24 = Time

↑ Arrow indicates exceeded limit value

1.550 = measuring value

n = number of readings
 \bar{x} = mean value
 δ = standard deviation
 1.5 mm = active steel ball dia.
 FH4 = sensor type connected
 Z = calibration method, in this case zero calibration

n	93	max	1.565 mm
\bar{x}	1.4558 mm	Setting upper limit	1.500 mm
σ	14.62 μ m	Setting lower limit	1.400 mm
	1,5 mm	min	1.424 mm

FH4 /data/Bottle LD-PE.csv

Calibration Statistics Delete min/max

Battery symbol = Mains or battery operated / Charging status and remaining battery time

max = maximum reading
 Setting upper limit
 Setting lower limit
 min= minimum reading
 Bottle LD-PE = Active batch
 Status bar

The currently activated function of the function buttons is shown on the bottom line of the display above the respective function button. They take on different functions depending on the active menu. In measuring mode, the buttons take on the following functions: Calibration - Statistics - Delete min/max.

4.3.2 Measuring mode – Screen with numerical display

communication symbols

11:24 = Time

max = maximum reading
Setting upper limit
= 1.500 mm

1.460 mm = reading

Setting lower limit = 1.400 mm
min= minimum reading
n = number of readings
FH4 = sensor type connected
Z = calibration method,
in this case zero calibration

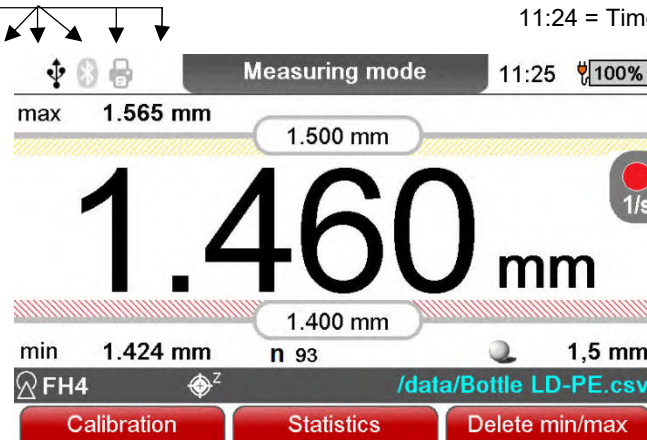

Battery symbol = Mains or battery operated / Charging status and remaining battery time

Logging rate of readings per second in data „Auto“ = 1 reading / second

1,5 mm = active steel ball dia.

Bottle LD-PE = active batch
Status bar

4.3.3 Measuring mode – Graphical screen showing online trend

Communication symbols

11:24 = Time

n = number of readings ↑

online trend of readings
Each point of the graph shows a reading logged to the memory.

FH4 = sensor type connected
Z = calibration method,
in this case zero calibration

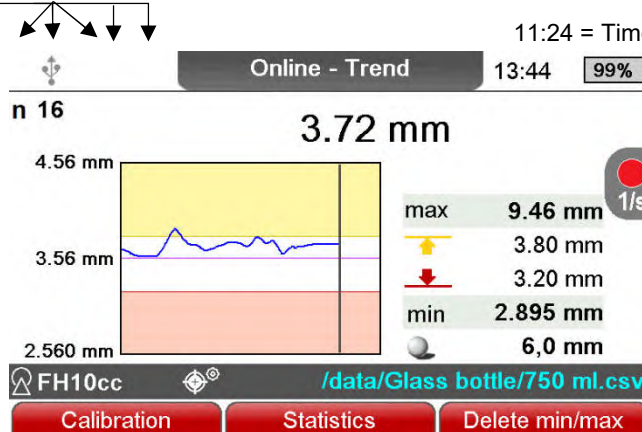

Battery symbol = Mains or battery operated / Charging status and remaining battery time
1.458 = reading

max = maximum reading
Setting upper limit
Setting lower limit
min= minimum reading
1.5 mm = active steel ball dia.

AAAAA = active batch
Status bar

The currently activated function of the function buttons is shown on the bottom line of the display above the respective function button. They take on different functions depending on the active menu. In measuring mode, the buttons take on the following functions: Calibration - Statistics - Delete min/max.

Settings for the real time trend are carried out in the submenu „Batch configuration“.

To ensure optimum utilisation of the real-time trend, it is necessary to enter limit values (see chapter 8.1.1 “Upper and lower limits“).

4.3.4 Measuring mode – Screen with numerical display in setpoint mode

An error signals that the preset limit value has been exceeded.
515 µm = difference to setpoint

n = number of readings
 \bar{x} = differenc to mean value
 δ = difference to standard deviation
 1.5 mm = active ball dia.
 FH4 = sensor type connected
 Z = calibration method, in this case zero calibration

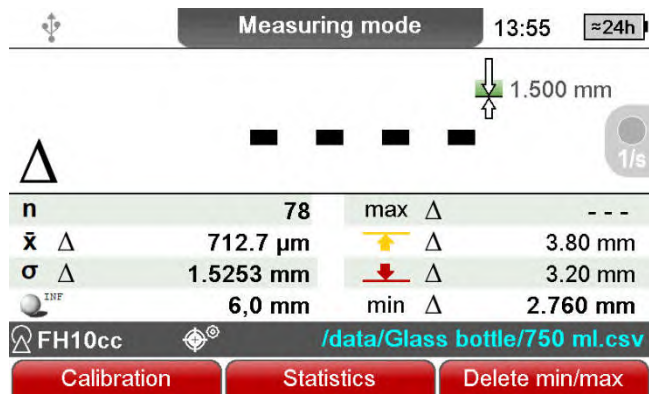

1.515 mm = reading
1.000 mm = setpoint

max = highest difference to setpoint
 Setting upper limit
 Setting lower limit
 min = smallest difference to setpoint
 AAAAA = active batch

The currently activated function of the function buttons is shown on the bottom line of the display above the respective function button. They take on different functions depending on the active menu. In measuring mode, the buttons take on the following functions: Calibration - Statistics - Delete min/max.

4.3.5 Statistical screens

Cp/Cpk: Process capability index

FH4 = sensor type connected
 Z = calibration method, in this case zero calibration



The arrow symbol ▷ on the right of the number of readings indicates that further information can be displayed by pressing the arrow right key. In this case, distribution of measuring values can be visualized.





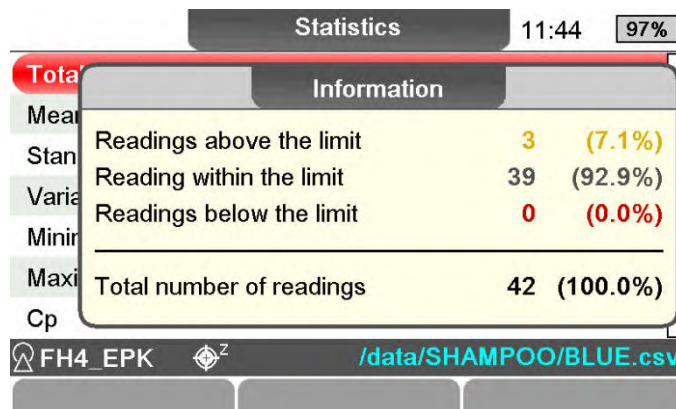





The arrow symbol ▼ in the scroll bar indicates that another statistical value underneath those on the display can be shown. Scroll down to display the Cp value.

The currently activated function of the function buttons is shown on the bottom line of the display above the respective function button. They take on different functions depending on the active menu. In measuring mode, the buttons take on the following functions: Histogram- Readings-Actions





4.4. Display symbols





4.4.1 Communication symbols in headline:



Possible communication symbols in headlines. Not all symbols are displayed permanently or at the same time.				
	coupled	Active	inactive	
				Bluetooth
	USB connection (VCP)	Connected but operation mode None	No connection	
				USB
	Data output	Actively selected t	No selection	
				RS232
	activated	Connected	No connection	
				Foot switch
	Print-out	Coupled	No coupling	
				Printer

4.4.2 Sensor symbols in status bar:

Defective sensor	Batch is configured for another sensor.	Sensor connected	No sensor connected	
				Sensor

4.4.3 Calibration symbols in status bar:

Symbol	
	Factory settings activated
	Quick calibration or in case of a multi-point calibration only the zero calibration has been performed and is active.
	Multi-point calibration with zero and one precision standard has been performed.
	Multi-point calibration with zero and two precision standards has been performed.
	Multi-point calibration with zero and three precision standards has been performed.

	Multi-point calibration with zero and four precision standards has been performed.
	Multi-point calibration without zero and two precision standards has been performed. For further calibrations only a number is added.

4.5 Navigation in the menu system

The MiniTest FH features numerous functions that are organized in a flat menu structure. Essential functions such as calibration and statistical information on the active measurement series can be called up directly from measurement mode via function keys.

The top menu level is the main menu. Submenus can be selected in the main menu, which contain parameter pages and submenus. This section describes the navigation within the menu system using a few examples. Press the menu key  to access the menu system.



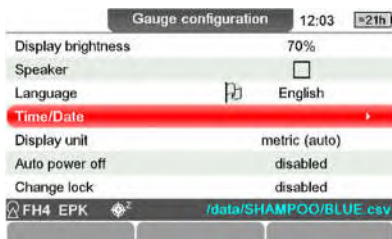

Select a menu item from the main menu using the arrow keys “↑” or “↓” e.g. “Gauge configuration “ and confirm with the “OK” key  to enter this submenu.





The submenu “gauge configuration“ contains parameter settings as well as a further submenu “Time/Date“. To access for example the submenu “Time/Date” use the arrow keys “↑” or “↓” to select this menu and confirm again with OK  to open this submenu.



The "Time/date" submenu does not contain further submenus but is a parameter page. The use of parameters is described in the following section 4.5.



Press the “ESC“ key  to return to the previous menu. Pressing the “ESC“ key  while in the main menu, the measuring screen is displayed. In a submenu such as "Time/date", press the "ESC" button  to return to the higher-level menu here "Gauge configuration".

Pressing the "Menu" button  takes you directly to the main menu. Pressing and holding the "ESC" button  takes you directly from a submenu to the measurement screen.

Using the operating options described beforehand to navigate through the entire menu system and access each individual menu page.

4.6 Parameter setting



Many screen pages are not submenus but contain parameters whose values can be changed by the user (with a few exceptions). There are various parameter types; the procedure for setting them depends on the type. This section describes the setting methods for the various parameter types using one example each.

The parameter currently selected on a parameter page is highlighted in red. Use the arrow keys “” and “” in order to move the cursor up and down on this screen page. If you move the cursor beyond the bottom of the screen, it will move to the parameter at the top of the screen and vice versa (this can be used to minimize the number of keystrokes). The cursor only marks the selected parameter; no changes are made at this point. The following paragraphs explain how to access the so-called editing mode to change a parameter value for each parameter type.

There are parameters which are only intended for information and cannot be changed on some parameter pages (e.g. "Characteristic data"). This is always indicated by the fact that no selection cursor is visible.

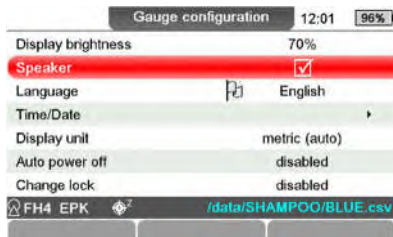



4.6.1 Setting switching parameters (Example: Speakers)



Some parameters only have two possible states, e.g. "on" and "off" or "active" and "not active". These parameters are referred to as switching parameters. Such a parameter is, for example, the "Speaker" parameter in the "Gauge configuration" submenu. Use the menu functions to navigate there and select the "Speaker" menu item. Press the "OK"  key. The parameter changes state, e.g. to "ON" . Press the "OK"  key again. The parameter changes state back to "OFF" etc. The status displayed in each case is also the status set.

4.6.2 Setting selection parameters (Example: Language)





Selection parameters have more than two possible states, e.g. the "Language" parameter in the "Gauge configuration" submenu. Use the menu functions to navigate to this menu and select the "Language" menu option, for example. Press the "OK" button . The selection box is displayed. Use the keys „” or „” to toggle through the list of options and make a selection., e.g. „English“. Press the OK button  to adopt the selected value into the setting.

However, in order to keep the previous parameter setting, press the "ESC"  key.

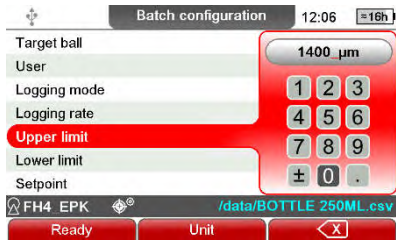
4.6.3 Setting numerical parameters (Example: Upper limit)



For parameters that require a numerical input, a special input window appears after selecting the parameter to be set. The "Upper limit value" parameter serves as an example here.

The arrow keys     serve to navigate and select a character.

The value is adopted with the "OK"  key.

You can delete the last character in the input line with the function key "" after a typing error (even several times in succession).





To change the measuring unit, use the function key "Unit".

After entering the appropriate numerical value, press the function key "Done". Press the "ESC" key  to maintain the previous value of this parameter.

4.6.4 Setting alphanumerical parameters (Example: Folder name)



When parameters require alphanumerical (text) data entry, a special dialog box appears after selecting the parameter to be set. The entry of the folder name when creating a new subfolder serves as an example as follows (see also chapter 7.2.4). Any name up to a maximum of 15 characters can be entered.

The arrow keys     serve to navigate and select a character.

The value is adopted with the "OK"  key.

You can delete the last character in the input line with the function key "<X>" after a typing error (even several times in succession). The function key "abc ('123)" serves to switch between numbers, letters and capitals. The name of the function keys changes depending on the keypad selected: For the upper case keyboard "abc ('123)", for the lower case keyboard #123 (ABC), for the numeric keyboard ABC (abc), as an indication of which keyboard will be called up the next time the function key is pressed.

After entering the appropriate text, press the function key "Done ". Press the "ESC" key  to maintain the previous value of this parameter.

5. Measure Mode

5.1 Important Notes on Thickness Measurement

Make sure that the operator has been properly instructed regarding the use of thickness gauges and has basic knowledge of the specific requirements for measurement of the application. The operator should have basic knowledge of the following:

- Selection of a measuring device suitable for his application
- Fundamentals on the magneto-static measuring principle
- Influences on the magnetic fields through the surrounding field
- Influence of the surface properties of the material to be tested (roughness, build-up on the surface)
- Statistical evaluation of measuring series
- Gravity influencing the reference ball

5.1.1 Limitations to magneto-static thickness measurement

The information obtained from thickness measurements according to the magneto-static principle only refers to those parts of the test object that have been covered by the magnetic sensor. For that reason, be careful to draw conclusions on other parts of the measuring object that have not been covered by the sensor during measurement. In general, such conclusions is not admissible unless comprehensive experience and approved methods of statistical data acquisition are available.

5.2 Batch Configuration / Necessary Settings

Before measurement, the necessary settings are to be made in the "Batch configuration" menu and during initial commissioning in the "Data storage" menu item of the "Data output" submenu, see chapter 10.6.1 "Data storage".

5.2.1 Batch

- You can continue to take readings in the active batch
- You can create a new batch
- You can choose an existing batch from the database (please refer to section 7.2).

5.2.2 Target Ball Size

Adjust the ball diameter in the calibration menu or in the main menu "Batch configuration", menu item "Measuring ball" according to the sensor type and adapted to the geometric properties of the measurement object" (see also chapter 6 "Calibration").

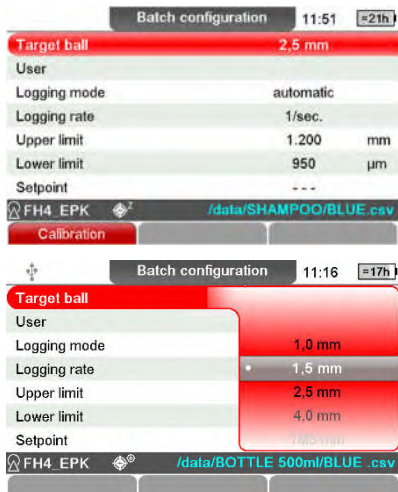

Open the dialog box for the steel ball diameter pressing the "OK" key. Use arrow keys to adjust the requested target ball size. Press OK to confirm your setting or press ESC to undo your setting. If you undo, you will automatically quit the target ball setting option and go back to the previous menu level.

Note: The magnetized steel balls are identified by indication of the diameter and the additional information of the letter "M" e.g. „3M0“ for a magnetized steel ball with 3 mm Ø.

5.2.3 Data Logging Mode

In the data logging mode you can specify how you wish readings to be stored in memory. Several modes are available:

manually or via foot switch

Automatic (Auto) see section 5.5.1

Note: For logging data into memory please always proceed as follows: Put the sensor into the correct measuring position, press „Delete min/max“. Then readings can be taken.

5.3 Preparing Measurement

Before measurement, the probe must be adapted to the ambient temperature. In case of high variations in temperature, the target ball must be lifted from the probe tip at regular intervals (e.g. every other minute). This is to compensate for frequency drift due to variations in temperature. It is recommended to switch on the gauge for warming up around 2 to 3 minutes in order to ensure maximum measuring accuracy.

5.3.1 Calibration

According to your setting of task, you may use different calibration methods. Measuring accuracy depends on the selected calibration method. Please refer to section 6 for more details on this subject.

There are three calibration methods available:

Factory (not applicable for FH cc sensors with interchangeable caps)

Quick calibration

Multi-point calibration

A particularly innovative function of the MiniTest FH is the quick calibration, which automatically determines the correct ball diameter and performs a zero-point calibration.

5.3.2 Measurement without Sensor Stand

For measuring large-sized parts, the sensor can be guided manually over the measuring sample. For measuring thick samples (6 mm and thicker) make sure to keep the sensor in vertical position to the sample. When holding the sensor in horizontal position, due to the influence of gravity on the steel ball, the readings will be higher than the actual thickness.

5.3.3 Using the Sensor Stand

For measuring small parts, bottles or other cylindrical bodies the sensor stand (supplied with the sensor) and a foot switch (available as an option) should be used.

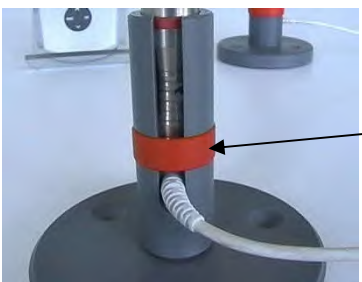

Put the sensor into the stand and secure with the red retaining ring.

5.4 Take Readings

5.4.1 Measuring without sensor stand

For measurements on large-sized sheeting material or large hollow parts, place the sensor onto the surface of the object to be measured. Place an appropriate target ball on the opposite side of object near the sensor. The target ball is attracted by the strong permanent magnet of sensor and positioned centrally just opposite of the sensor tip. Keep the sensor in right-angle position to the object to be measured and scan continuously over the surface. For storing readings, please refer to section 5.5.2.



5.4.2 Measuring using the sensor stand

If you are using the sensor stand, position the sample on the sensor tip and keep it in right-angle position to the sensor. Place the appropriate target ball on the opposite side of object. Make sure to keep the right-angle position while moving the object continuously over the sensor. For storing readings, please refer to section 5.5.2.

When measuring small hollow parts such as bottles e.g., put the target ball inside the object and place the object onto the v-grooved device of sensor stand. Turn the object until the target ball is centred directly over the sensor tip. Then move the object continuously over the v-groove of sensor stand. For storing readings, please refer to section 5.5.2.

5.4.3 Delete Readings

Please refer to section 8.2.2 "Delete Single Readings".

5.5 Storing Readings into Statistics Memory

5.5.1 Data Logging Mode



During measurement, readings can be stored into memory manually or automatically. Data in memory will be used for statistics. Data can also be transferred via the interface (please refer to section 10.5.4.2).

The following storing options are available:

- Storing the current reading manually or automatically
- Storing the minimum reading (only manually)
- Storing the maximum reading (only manually).

Settings are made in the "Batch configuration" submenu in the "Loggin mode" menu item.



Open the dialog box "Logging mode" pressing the "OK" key  and use the arrow keys to set the parameters (automatic, current measured value, minimum, maximum).

Make your selection and press "OK"  to confirm. If you wish to undo your setting press „ESC“  and the gauge will return to the previous menu level.

5.5.2 Manual Data Storage

During measurements, current readings can be stored manually into the active batch by pressing OK or by actuating a foot switch. Open the dialog box „Logging mode“ of the submenu „ Batch configuration“ and select "Current reading".

5.5.3 Automatic Data Storage (Auto)

In the auto mode, readings will be stored automatically during the measuring procedure as soon as you press "OK" . To stop the automatic data storage press "OK"  again. If a foot switch is connected, readings are stored as long as the foot switch is actuated.

Before starting the automatic data storage make sure the sensor is placed in the correct measuring position. Make sure to stop the automatic data storage BEFORE the sensor has left the measuring position. This is to avoid erratic readings from being stored into memory. If you lift the sensors, readings will be erratic as contact with the sample is needed.

After setting the Data logging option to the Auto option, a Logging rate option will appear. The logging rate defines the time intervals at which data will be stored into memory (1, 2, 5, 10 or 20 readings per second). For slow measurement scans, a low logging rate should be set.

5.5.4 Storing Minimum Reading

In the Minimum option, minimum readings will be stored to the active batch by pressing „OK“  during measurement or by activating a foot switch.

Open the dialog box “Logging mode“ of the submenu “Batch configuration“ and select “Minimum”.

Please note: The minimum reading can also be stored even after the sensor has been lifted from the sample.

5.5.5 Storing Maximum Reading

In the Maximum option, maximum readings will be stored to the active batch by pressing „OK“  during measurement or by activating a foot switch.

Open the dialog box “Logging mode“ of the submenu “Batch configuration“ and select “Maximum”.

Important note:

To avoid that a maximum value is stored to the statistics before the correct measuring position has been reached, proceed as follows:

1. Put the sensor into the correct measuring position.
2. Press function key “Delete min/max“.
3. Take readings.
4. Press „OK“  to store the maximum reading into the statistics.
5. Lift sensor from the measuring object.

5.6 Error Sources during Measurement

After calibrating the gauge according to your application and appropriate target ball size, the gauge is ready for measurement.

The readings will be correct as long as you measure within the range as specified for this target ball. The target ball is placed on one side of the sample to be measured and will be attracted by the sensor tip on the other side of the sample. The target ball serves as a reference to the sensor. What is being measured is the distance between sensor and target ball.

Make sure to place both the sensor tip and the target ball correctly onto the sample. Both must be in good contact with the surface of the sample. Otherwise, erratic readings (higher readings) might occur. Make sure to keep the sensor in perpendicular position while moving it over the sample. The target ball on the other side must be freely movable.

5.6.1 Correct Sensor Position



The picture illustrates the correct position of sensor tip and steel ball. Make sure to keep the sensor tip perpendicular to the surface of sample.

5.6.2 Incorrect Readings through tilting of the Sensor

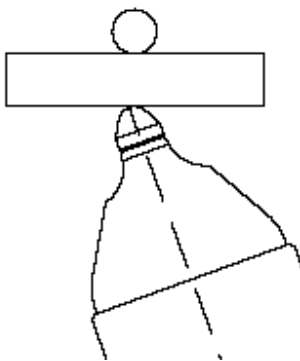

Error source:

The sensor tip is not positioned correctly in perpendicular position to the sample. The reading will therefore be higher than the actual thickness.

Remedy:

Make sure to keep the sensor in perpendicular position to the sample. If necessary, use the sensor stand.

5.6.3 Incorrect readings through Blocked Target Ball

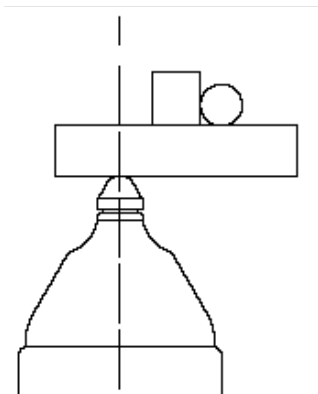

Error source:

The target ball has got stuck through a bulge, e.g. inside the sample. It is out of the correct measuring position.

Remedy:

Move the sample in order to release the target ball.

5.6.4 Air Gap

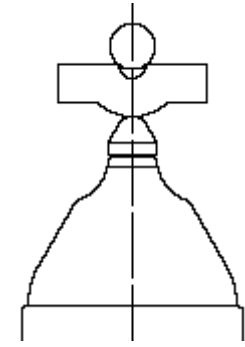

Error source:

Due to the shape of sample, an air gap is between target ball and measuring object. The reading will be higher than the actual thickness.

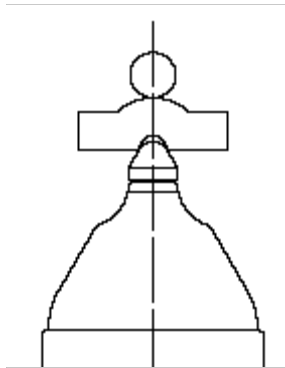

Remedy:

If the target ball is too large, use a smaller one. If the sensor is not in good contact, change measuring position and use a smaller target ball, if necessary.

5.6.5 Measuring material with ferruginous particles

Ferruginous particles in the material to be measured may lead to erratic readings because the ferruginous particles may influence the measuring signal. This will lead to readings smaller than the actual thickness.

5.6.6 Influencing magnetic fields through environmental influences

The magnetic field of the sensor can be influenced by objects made of ferromagnetic material and magnetic fields in the environment. This can affect the measurement accuracy. Ferromagnetic objects are, for example, worktables that have a frame, supports, stand or plate made of steel. Electromagnetic fields are emitted by electric motors, transformers or computers.

Always keep the sensor at a distance of at least 30 cm from these objects.

5.6.7 Influence of the surface quality (roughness, cleanliness) of the test material on the measurement

Rough or grooved surfaces can block the movement of the measuring ball when scanning the surface, whereby greater thicknesses can be displayed. Move the test piece slowly over the sensor tip and only transfer readings to the data memory when the target ball is centered over the tip. Alternatively, use the minimum value mode.

5.6.8 Influence of gravity on measuring values

When measuring on vertical surfaces with the sensor in horizontal alignment, the gravitational force of the target ball can lead to an offset in the alignment of the sensor tip and steel ball, resulting in a larger measured value. In this case, move the sensor more slowly over the surface and ensure that the magnetic adhesion between the sensor and the target ball is maintained in order to prevent the steel ball from falling down.

5.6.9 Measurement using magnetized steel balls

Measuring with magnetized steel balls requires extraordinary diligence. Magnetized steel balls with same diameter as standard steel balls do possess a magnetic field of different force. Hence, a calibration is always required before starting a measurement with magnetized steel balls. Working with the factory calibration is not recommendable (see 6.3 “How to calibrate“).

In contrast to standard steel balls, the magnetized steel balls will not roll over the surface of the object to be measured but are always aligned anti-parallel to the sensor due to physical reasons. Especially when measuring on rough surfaces, this will result in a retarded tracking of the magnetized steel ball and hence to increased measuring values. For these applications, you should either use the display of the minimal value or alternatively wait until the magnetized steel ball has reached the center position over the sensor tip before the reading is logged in the data memory.

The temperature coefficient of magnetized steel balls is different from those of standard steel balls. This fact cannot be compensated by the sensor integrated temperature compensation. It is thus important to assure the same temperature of the steel ball during calibration and during measurement. In case the temperature of the magnetized steel ball changes during measurements, all deviations in measurement should be verified using a control standard and if necessary, calibration must be repeated.

5.6.10 Measurement using steel wires

When measuring with target wires, the sensor tip must be at least 25 mm from the end of the target wire, otherwise larger measured values may be displayed. The target wire must not be bent or twisted too much. Make sure that the target wire is pressed firmly against the test part at the point to be tested. Ensure that there is no gap between the test object and the measuring wire. Otherwise, this will lead to higher measuring values.

5.6.11 Sensor alignment

The measuring method of the sensor is based on the fact that an electronic element in the sensor tip detects the change in the magnetic field caused by a measuring reflector (steel ball, steel wire) at a distance from the sensor tip. This electronic element also reacts to the Earth's magnetic field. In standard applications, the sensor in the measuring stand is in constant vertical alignment; here the influences are compensated for by the electronics. However, if parts such as large plastic containers are to be measured with the sensor aligned horizontally, press the "New infinity" function key in the submenu "Sensor configuration".

The sensor is adjusted to the horizontal position. If the sensor is again used in vertical position in the measuring stand, it is automatically adjusted to the vertical position over a period of a few minutes. During this adjustment time, there may be deviations in the measurements. These deviations can be avoided directly by setting a "new infinity", as described for horizontal alignment.

6. Calibration

Calibration is made in the batch being active and will always refer to this batch, i.e. each batch has its own calibration. Before calibration, an appropriate target ball diameter and type ("M") must be set in the **Calibration** menu. Please refer to section 5.2.2 "Target ball size".

Press the function key "Calibration" in measuring mode to open the menu for calibration.

For selecting an appropriate target ball, the following aspects should be taken into consideration:

- minimum radius of sample to be measured
- maximum thickness to be measured
- required measuring accuracy

Sensor	Target Ball	Minimum internal radius of measuring object	Measuring range
FH 2	Ø 1,5 mm	0,75 mm	0 ... 0,6 mm
FH 2	Ø 2,5 mm	1,25 mm	0 ... 1,3 mm
FH 2	Ø 4,0 mm	2,0 mm	0 ... 2,3 mm
FH 2_M	Ø 1,5 mm magnetized steel balls	0,75 mm	0 ... 2,0 mm
FH 2_M	Ø 3,0 mm magnetized steel balls	1,5 mm	0 ... 4,5 mm
FH 4_1	Ø 1,0 mm	0,5 mm	0 ... 1,3 mm
FH 4	Ø 1,5 mm	0,75 mm	0 ... 2,0 mm
FH 4	Ø 2,5 mm	1,25 mm	0 ... 3,5 mm
FH 4	Ø 4,0 mm	2,0 mm	0 ... 6,0 mm
FH 4_M	Ø 1,5 mm magnetized steel balls	0,75 mm	0 ... 5,0 mm
FH 4_M	Ø 3,0 mm magnetized steel balls	1,5 mm	0 ... 9,0 mm
FH 10	Ø 2,5 mm	1,25 mm	0 ... 4,0 mm
FH 10	Ø 4,0 mm	2,0 mm	0 ... 7,0 mm
FH 10	Ø 6,0 mm	3,0 mm	0 ... 10 mm
FH 10	Ø 9,0 mm	4,5 mm	0 ... 13 mm
FH 10_M	Ø 4,0 mm magnetized steel balls	2,0 mm	0 ... 16 mm
FH 10_M	Ø 6,0 mm magnetized steel balls	3,0 mm	0 ... 24 mm

6.1 General Remarks on Calibration

For achieving maximum accuracy, please observe the following calibration instructions:

- Make sure to keep off strong magnetic fields from the sensor during measurement.
- Keep away from any ferromagnetic metal parts in a safety distance of at least 30 cm.
- It is recommended to switch on the gauge for warming up around 2 to 3 minutes before starting calibration procedure.
- Make sure the sensor tip, target balls and calibration standards are clean. Any foreign matter may lead to erratic readings.
- For maximum accuracy of calibration and later measurements, choose the thickness of calibration standard within the same thickness range as the later measuring sample.
- In some cases it may become necessary to recalibrate if a new target ball is used (also if it has the same diameter as the previously used one). To be sure, check calibration in measuring mode by putting the matching precision standard with the appropriate target ball on the sensor.
- Please note that large target balls will compress soft material more than small target balls.

Note:

If the MiniTest switches off during the calibration process in battery mode because the battery is empty, calibration must be repeated. Charge the battery beforehand or calibrate while supplying the device with power via the USB plug-in power supply unit.

Please Note:

Each time the target ball is removed from the sensor tip in a distance of more than 30 mm, the gauge will automatically be adjusted to the infinite range. Any possible drift influences (e. g. through variations in temperature) will be extensively compensated. The more often the target ball is removed from the sample, the more often compensation will take place so as to increase measuring accuracy.

For that reason it is recommended to lift the target ball from the sensor tip at least every three minutes. A message will appear on display accordingly to remind you to repeat infinite setting (“Refresh infinite Value !!!”).

To ensure measuring accuracy, check calibration after one hour of use of the gauge and recalibrate if necessary.

6.2 Calibration methods

According to your setting of task, you may use three different calibration methods.

Measuring accuracy depends on the selected calibration method. The following calibration methods are available:

- **Factory calibration**
 This calibration method is suitable for quick and simple measurement and if larger measuring errors are admissible as compared to zero calibration. This method is not at all recommended when working with magnetized steel balls and not applicable for cc sensors.
- **Quick calibration.**
 The correct target ball size is automatically detected and a zero calibration is performed.
- **Zero point calibration**
 This method is for quick calibration with a medium measuring accuracy.
- **Multi-point calibration**
 Multi-point calibration allows the zero point to be calibrated and with up to four precision standards with various thickness values. In most cases a two-point calibration (Zero + one standard) will be sufficient providing that calibration is made in the range of thickness to be expected. Further calibration points are recommended if measurement will be over a larger thickness range and if a high accuracy is required. When using magnetic target balls, a multi-point calibration should always be carried out with precision standards whose thicknesses are distributed over the complete measuring range.
-

6.3 How to calibrate





Using the sensor stand will add additional comfort during the calibration procedure. For more details please refer to section 5.3.3.

For all calibration methods the following applies:

- Open the calibration menu pressing the function key „calibration“ when the gauge is in measuring mode.

Quick calibration can be started directly pressing the function key „Quick calibration“ in the calibration menu.

For calibration methods “Factory calibration“ and „Multi-point calibration“ proceed as follows:

- Open the calibration menu and adjust to the correct steel ball diameter. Open the dialog box "Target ball" pressing the "OK"  key and adjust to the correct diameter of the steel ball using the arrow keys. Confirm the setting with the "OK"  key (see section 5.2.2).
- Access the dialog box "Calibration method" using the arrow keys and confirm with "OK"  key. Select a calibration method and confirm with "OK" .

6.3.1 Factory Calibration



Use arrow keys to select „Factory Calibration“. Press "OK"  to confirm.

Press the "ESC"- key, the gauge is ready for measurement.

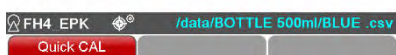

6.3.2 Quick calibration



Press the function key „Quick calibration“ in the calibration menu and place a zero cap and steel ball of corresponding diameter on the sensor. The steel ball diameter is detected automatically and a zero calibration is performed. The zero point calibration is a calibration with a sufficient degree of accuracy.

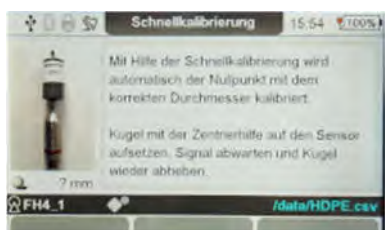
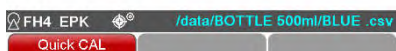

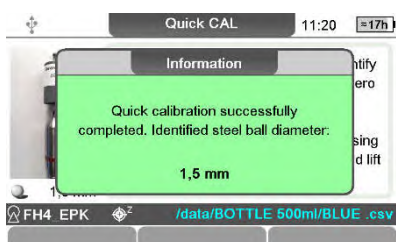

When the gauge indicates completion of the quick calibration, confirm pressing the "OK"  key. Measurement can be started immediately.

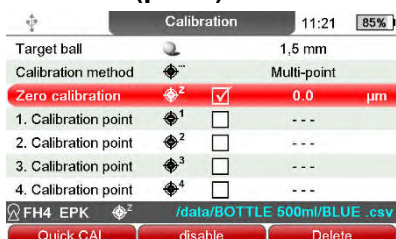

6.3.3 Zero (point) calibration



Open the dialog box "Calibration method", select "Multi-point calibration" and confirm with "OK" .

Now move the cursor on "Zero calibration" using the arrow keys and confirm with the "OK"  key.

For zero point calibration, the zero standards supplied with the gauge must be used together with the matching target balls. Make sure always first to place the target ball into the zero standard. Then

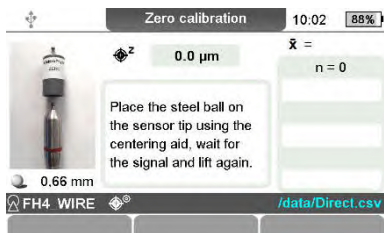

put both together onto the sensor. Wait for the sound to bleep, remove the precision standard and keep it in a distance of at least 30 mm.

To calculate an field value, repeat the process several times. The mean value is displayed in the right field " $\bar{x} =$ ". The individual readings should not vary too much, otherwise press the "New" function key and repeat the process.

Validate and confirm the zero calibration with the function key "Ready".

A tick now appears in the box to the right of "Zero calibration" on the display.

Quit the calibration menu with the "ESC"- key and return to measuring mode.



Zero calibration standard with inserted target ball

6.3.4 Multi-point calibration (Zero + 1 to 4 point(s))

For multi-point calibration you must first carry out a zero-point calibration. The precision standards must be used (1 to 4 as requested) to calibrate for the further calibration points. The precision standards have different thickness values.

1. In most cases a two-point calibration (Zero + one standard) will be sufficient providing that calibration is made in the range of thickness to be expected.
2. Further calibration points are only necessary if measurement will be made over a larger thickness range and if high accuracy is required.



Perform a zero calibration as illustrated in section 6.3.3.

Then, set the cursor on "1. Calibration point" using the arrow keys and start the calibration with the "OK" key.

Use the function key "Edit" to enter the thickness value of the precision standard through the numerical input screen. This is also possible at a later stage after the measurements for calibration were taken with the precision standard.

Only use precision standards supplied by ElektroPhysik. Always ensure first to place the target ball into the zero standard. Then put both together onto the sensor. Wait for the sound to bleep, remove

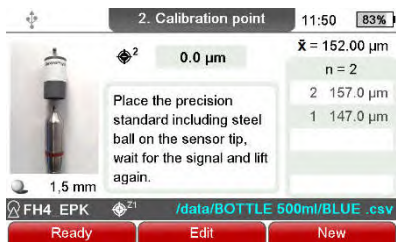

the precision standard and keep it in a distance of at least 30 mm. For calculation of a mean value, it is recommended to repeat the procedure several times. (To get reasonable values it is always recommended to take several readings and to have the mean calculated). The current calibration value, which was calculated from the individual readings, is shown on the display in the " \bar{x} " field. If the thickness value of the precision standard has not already been entered, the average value is also displayed in the middle field. Once the calibration value matches the thickness value shown on the precision standard, press the function key "Ready", to complete the calibration process. Otherwise press function key "Edit".

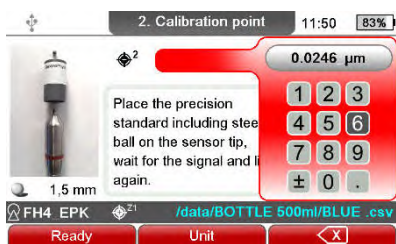

Enter the value of the precision standard and the appropriate unit of measurement in the numerical input field. Use the function key " $\langle X \rangle$ " to delete numbers that are not correct. In order to switch between measuring units, e.g. μm and mm , press the function key "Unit".

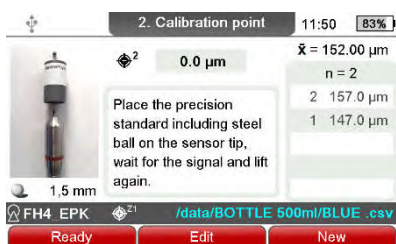

Complete the procedure pressing the function key "Ready".

If the thickness of the precision standard has already been entered, or is present through a previous calibration, the "Done" function key can be pressed directly after the appropriate number of calibration measurements.

The thickness value of the precision standard is displayed in the middle gray field.

If a different precision standard was used at this calibration point, press the "Edit" function key to enter the new thickness value.

Further calibration points can be added following the same procedure. The box column in the calibration menu provides an overview of the progress of the calibration. Points that have already been calibrated are marked by a box with a tick.

Once having entered the last calibration value, measurements can now be taken directly. To exit the calibration menu, press the key "ESC" .

6.5. Deactivate or delete calibration point

Use arrow keys to move to the calibration point to be deleted.

Press the function key "Deactivate". The tick in the control box disappears (\square) and the thickness value of the precision value is maintained. In order to finally delete the calibration value, press the

function key "Delete", the calibration value is deleted and tick in the control () and the calibration value removed..

6.6. Calibration Error Sources

The following situations may lead to erratic calibration:

Error:	Remedy:
Wrong target ball:	Select an appropriate target ball suitable for your measuring sample and the thickness to be expected. Adjust to the correct target ball size via the menu.
Calibration range does not match to the thickness to be expected.	Calibrate within the thickness range to be expected.
During calibration, the precision standard has not been placed correctly on the sensor tip.	Make sure to fully engage the precision standard on the sensor tip.
Calibration error due to changes in temperature	Before calibration, the sensor must be adapted to the ambient temperature. Please wait 30 minutes after switch on before starting measurement.
Worn or damaged precision standards:	Please use new precision standards in impeccable condition.
Build-up on the sensor tip.	Clean sensor tip from metal parts, dirt particles etc. by using a soft cloth.

7. Data Storage

7.1 Batches

7.1.1 General

Readings and their statistics will be stored in batches. These batches are either stored directly in a database or in folders with up to five sublevels. One batch is firmly installed under the name "Direct Mode". This batch cannot be deleted, nor can it be renamed.

7.1.2 Batch Data

7.1.2.1 Readings

Measuring values and statistics can be stored in a batch. The possible number of measuring values that can be stored is several million. The total number depends, among other things, on whether the time stamp of a measuring value should also be saved.

7.1.2.2 Calibration Values

Calibration always refers to a certain measuring batch. As soon as a measuring batch is called, the corresponding calibration will become active. The calibration includes the following parameter settings: diameter of target ball, type of calibration and sensor.

7.1.2.3 Other parameters

The settings entered in the "Batch configuration" submenu, data mode, recording rate, upper and lower limit value and set point, are linked to the batch and are activated when the batch is called up.

7.2 Database of the MiniTest FH

7.2.1 General Remarks

The database is used to manage directories and the associated batches. The directories and batches can be named alphanumerically.



7.2.2 Tree structure



Example for a tree-structured database divided in directories and batches. At first use of the MiniTest FH, the database only includes one batch named "Direct Mode". You can create other directories or batches as required.

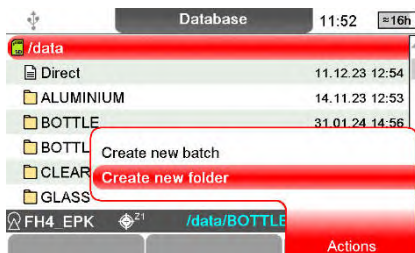

7.2.3 Create folders



Press function key Menu  then select "Database" and press "OK"  to confirm.

In the "Database" display, the first line of the root directory "/Data" is highlighted in red. Directories with up to 4 subdirectories or batches can be created at this position. Further subfolders can be created underneath.



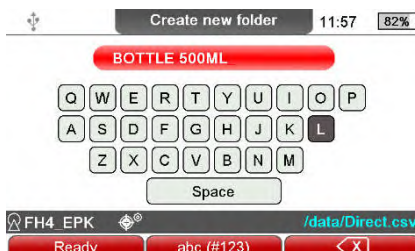

Press the function key "Actions", select "Create new folder" in the dialog box and confirm with "OK" . To abort, either press the function key "Actions" once again or the "ESC"  key.





Enter a name in the alphanumeric input field. For more details, please refer to section 4.6.4 "Alphanumeric Entries".

7.2.4 Create a New Batch



Open the main menu with the key menu , there select "Database" and confirm with „OK“ .

Use the arrow keys to move the cursor to the directory in which a new batch is to be created.

Press the function key „Actions“. In the submenu that pops up, select "Create new batch" and confirm with "OK" . To abort, either press the function key "Actions" once again or the "ESC"  key.

An alphanumerical keypad pops up to enter a name for the batch. See section 4.6.4 "Setting alphanumerical parameters".

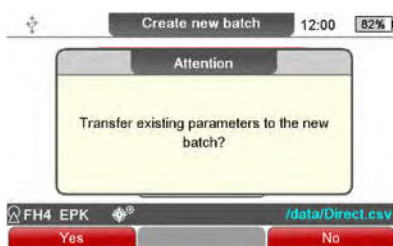

After the data has been entered, the dialog shown in the image appears. All parameters (calibration and batch configuration) of the active batch can be transferred to the new batch pressing the function key "Yes".

Parameters are set in the submenu "Batch configuration ". See section 10.4.3.

7.2.5 Select a Batch for Measurement



From **Main Menu** select "Database".

Use arrow keys to select the requested batch. Press „OK“  to confirm. The new batch is displayed in the status bar with the directory name and the file name, here `././Bottle 500ml/Blue.csv`

7.2.6 Delete a batch / folder



From **Measuring Menu** press function key "Main Menu" and select „Database“. Press „OK“  to confirm.

Use arrow keys to select the directory or batch to be deleted. Press function key "Delete" to confirm.

A confirmation appears. Press OK to confirm.



If there are subdirectories and other batches under a directory to be deleted, these will also be deleted.

Please note: The batch “Direct Mode” is a permanent part of the database. It can neither be deleted nor renamed. Nor you can assign a username to it. However, you can delete readings or statistical values.



Once you have deleted data they cannot be restored.

7.2.7 Rename a Batch / Rename a folder

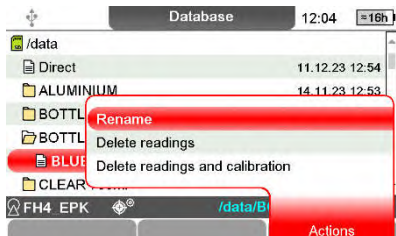

From **Measure Menu** press function key “Main Menu” and select “Database“. Press „OK“ to confirm. Use arrow keys to select the directory or batch to be renamed. Your selection will be highlighted. Press function key “Actions”.



Use arrow keys to go to “Rename”. Press OK to confirm.

On the alphanumerical input field the name to be changed appears. This name can be changed (see section 4.6.4 “Alphanumerical Entries”.) This action will not change the username.

8. Statistics

From **Measure Menu** press function key “Statistics“.

8.1 Statistical Parameters

The specifications for the statistics are made in the batch configuration (see 10.2.)

8.1.1 Upper and lower specifications limits (USL and LSL)

Tolerance limits can be set as requested and offer you the following features:

- Readings beyond the specification limits will be indicated by a signal tone and marked in the statistics.
- The process capability indices Cp and Cpk will be calculated according to the set specification limits.
- Areas above and underneath preset limit values will be marked in yellow (above limit) and red (below limit) in graphical illustrations trend diagram und histogram. This range will determine the real-time trend.
-

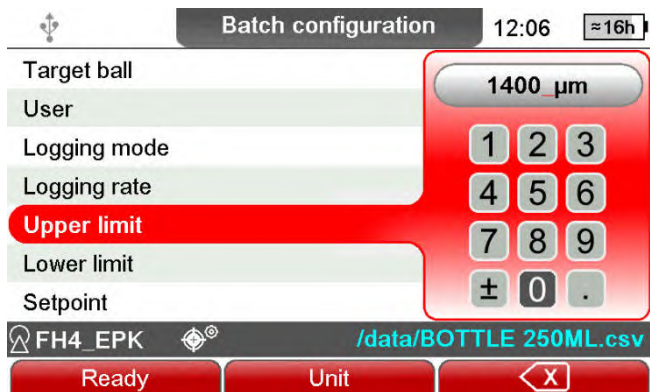

Parameters are set in the sub menu „Batch configuration“. Specify limits and measuring system (metric/imperial) as requested via the alphanumerical input field. See also section 4.6.3 “Alphanumerical Entries”.

Complete your setting by pressing Function key “Ready”. The gauge will check automatically whether your spec. limits are reasonable, for example: Input error, e.g. the upper limit value is smaller than the lower limit value.

Spec. limits can be deleted via the function key “Delete”.

Spec. limits can be set before or after readings have been taken.

8.1.2 Set Point (Differential Mode)

In quality control, it may be interesting to measure the difference between a set point and the actual thickness. Once you have specified a set point, the difference between this set point and the actual thickness will be displayed. A set point must be entered BEFORE storing the first reading. If you change a pre-set set point, the stored readings must be deleted previously.

The set point can be set in the "Batch configuration" submenu. Use arrow keys to go to "Set point" and enter a value as requested along with the correct measuring system (metric/imperial) via the alphanumerical input field. See also section 4.6.3 "Alphanumerical Entries".

Complete your setting by pressing Function key "Ready". Set point settings can be deleted via the function key "Delete".

8.2 Readings

8.2.1 View Readings

From **Main Menu** go to "Statistics". Press OK and select "Readings" submenu.

Individual readings are displayed as a list.

Use arrow keys to scroll through the batch as requested. Readings will be indicated along with their current reference number. The largest measured value in this list is labeled MAX, the smallest measured value is labeled MIN. If spec. limits have been set previously, information is included whether the readings have been above- (↑) or below (↓) the spec. limit.

8.2.2 Suppress individual readings

Readings		11:43	98%
Nr. 11		1.064 mm	
Nr. 12		1.068 mm	
Nr. 13		1.020 mm	
Nr. 14	MIN	1.018 mm	
Nr. 15		1.074 mm	
Nr. 16		1.168 mm	
Nr. 17	↑ MAX	1.228 mm	

FH4_EPK /data/SHAMPOO/BLUE.csv

Statistics Trenddiagram Suppress

Incorrect measurements can be suppressed from the list of individual measuring values. These are then no longer included in the calculation of the statistics. Use the arrow keys to position the cursor, in the form of a red bar, on the measuring value that you want to suppress. Press the function key "Suppress". Individual readings that have been suppressed are marked with (X). Suppressed individual readings can be restored to the statistics. To do this, position the cursor on the suppressed measured value and press the "Restore" function key.

8.2.3 Delete all readings

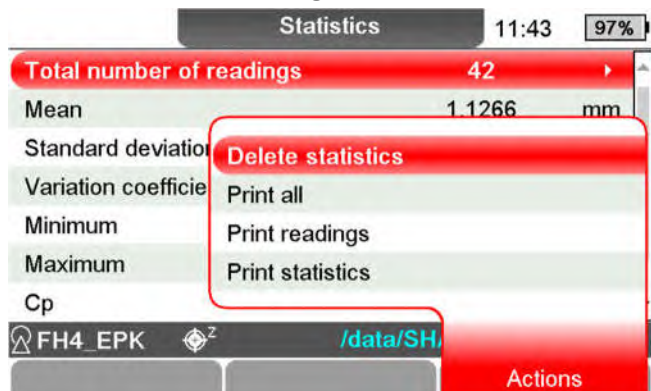

In order to delete all readings from a batch, two different options are available: Either in the submenu "Database" or directly from measuring mode via the dialog box „Statistics“. In measuring mode, press the function key "Statistics". Then press the function key "Actions" to open the dialog box and select "Delete statistics". A security prompt appears. Press „Yes“ to confirm and delete all measuring values of the active batch. Batch name, batch configuration of the sensor as well as calibration will be maintained.

To delete the measuring values from the main menu, go to the "Database" menu item via the "Main menu" function key and confirm with "OK".

Use the arrow keys to select the batch whose readings shall be deleted.

Press the function key "Actions" and select "Delete readings" or "Delete readings and calibration ". A security prompt appears. Press "Yes" to confirm and delete all readings or readings and calibration of this batch.

8.3 Numerical statistics

In measuring mode, access numerical statistics pressing function key "Statistics"

Number of readings

Statistics		11:44	97%
Total number of readings	42		
Mean	1.1266	mm	
Standard deviation	48.20	µm	
Variation coefficient	4.28	%	
Minimum	1.018	mm	
Maximum	1.228	mm	
Cp	0.86		

Buttons: Histogram, Readings, Actions

Process capability indices Cp and Cpk (if spec. limits have been set).

A vertical scroll bar is displayed on the right-hand side of the screen, indicating that another entry follows the "Cp" display; to display the Cpk values, move the cursor to the bottom of the screen using the arrow keys until the "Cpk" entry is displayed.

Alternatively, use the arrow keys to move the cursor beyond the top edge of the screen; it will jump to the parameter at the bottom edge of the screen, and vice versa.

If the cursor is on the entry " Total number of readings" and you press the „OK“  key, information on distribution of measuring values is displayed.

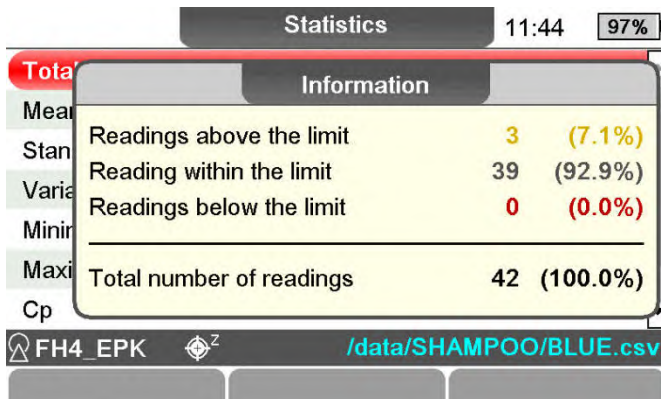

For more detailed information on statistics please refer to section 15.3.

8.4 Histogram on MiniTest FH

Use function key "Statistics" or function key "Histogram" to open the histogram during the measurement process.

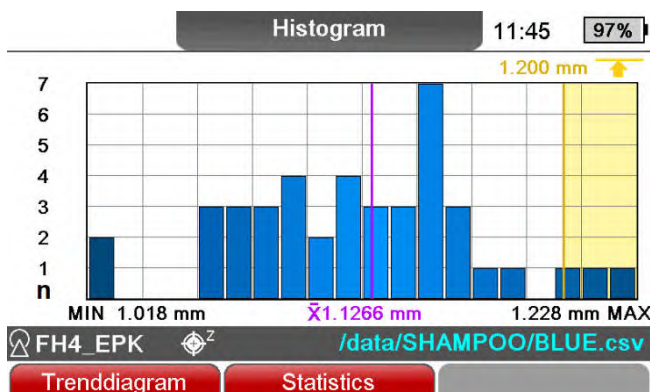

A histogram is a kind of plot that summarizes how data are distributed. It gives you information on how the production process might be changed in order to be optimized.

The limit range is the yellow and red highlighted area. See also (8.1.1 "Upper and lower spec. Limits").

Please note: For a histogram, a minimum number of 5 readings is required.

8.5 Trend Diagram on MiniTest FH

From measurement mode, you can call up the histogram via the "Statistics" function key, and alternately with the "Histogram" and "Trend diagram" function keys.

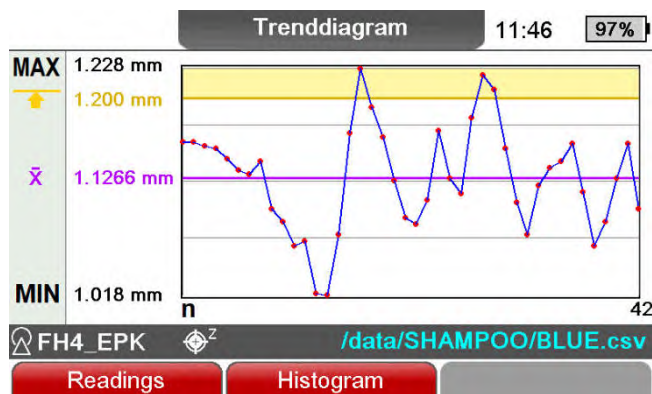

A trend illustrates the tendency of readings so that deviations can be quickly identified. The preset limit range is highlighted in yellow and red.

Note: For a trend-diagram, at least 5 readings are required.

9. Data output / Data transfer

The MiniTest FH is equipped with bidirectional USB and RS232-interfaces as well as a Bluetooth interface.

Measuring values can be:

- Transferred online to a PC or a measuring equipment multiplexer.

Measuring values and statistical values of a batch can be:

- sent to a PC software (terminal program) like for example MSoft7000,
- sent via the Bluetooth wireless interface to a Bluetooth data printer or
- sent to the Miniview APP for smartphones or tablets.

In addition, batches stored on the SD card of the MiniTest FH can be exported, data are stored in csv format.

9.1 Data print-out

Measuring as well as statistical values are transferred to Bluetooth data printer via the Bluetooth wireless interface.

The Bluetooth interface has to be activated. An active Bluetooth interface is shown through the  symbol in the display. Before printing, the printer must be paired with the MiniTest FH once (see section 10.5 Main menu "Interfaces").

Select "Bluetooth printer" in the "Data output" main menu in order print measuring values (see section 10.6.2.4 Data output: setting "Bluetooth printer").

The symbol for the printer  is displayed.

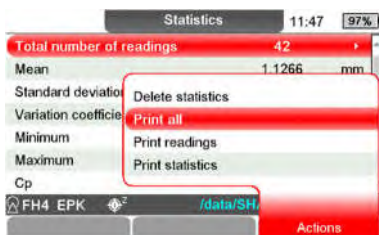

Measuring values and statistical values can be printed from the statistics screen. In measuring mode, call up statistics by pressing the function key "Statistics" then press function key "Actions" in order to open the dialog box.

Select "Print all", "Print measuring values" or "Print Statistics" in the dialog box and confirm with "OK"





Once the printing function is activated, the gauge display the message “Connecting printer” and the Bluetooth symbol is highlighted in blue.

Abort printing through pressing the ESC“ key.

9.1.1 Creating a screen shot.

The screen content of MiniTest FH can be saved in an image file in bitmap format (.bmp). This function is useful if a copy of the screen content is required for a report or for documentation purposes. For example, the histogram and the trend graph cannot be printed out via a data printer, but a copy of the screen content can be created. The screenshot can be made of practically any screen content so that settings can also be documented.

To create the screenshot, press and hold the "Menu" key.

The following message is displayed: "Gauge operation while generating the screenshot. Please wait...(approx. 15s)". The screen file is saved in the root /data of the database as screenShot_with date and time and can be displayed through pressing "OK" at this point or transferred to a PC by pressing the function key "USB storage " (see section 9.3).

9.1.2 Print-out a Batch

Please refer to section 9.1 “Data Print-out”

9.2 Transfer data to a PC

Before transferring data, go to the **Main Menu** and select “Setup”. Use arrow keys to move to “Data Output” and press „OK“ to confirm. Use arrow keys to select “USB (VCP)“, “RS232“, or “Bluetooth“ press „OK“ to confirm (See also section 10.5.4).

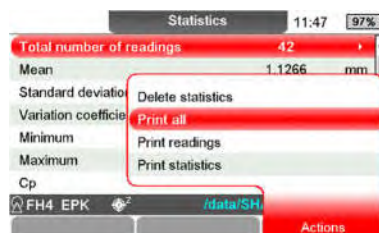

Measuring values and statistical values can be transferred from the statistics menu. In measuring mode, press the function key “Statistics“ and then function key “Actions“ to open the dialog box. Select “Print all“, “Print measuring values“ or “Print Statistics“ in the dialog box and confirm with “OK“.

To abort data transfer, press the „ESC“ key.

Note: Histogram and trend diagram cannot be printed. However, it is possible to create a screen shot and transfer the screen shot file to a PC (see sections 9.1.1. and 9.3)

9.3 Read out data via USB

Batches stored on the SD card including their measuring values as well as stored screen shots can read out from the MiniTest FH via the USB-interface.

When connected to a Windows PC or Apple Mac, the MiniTest FH behaves like a USB mass storage device, e.g. USB memory stick. Measuring values and screen shots are saved in the folder data.  data

The CSV file format stands for comma-separated values and describes the structure of a text file for storing or exchanging simply structured data. CSV files can be read by standard spreadsheet programs such as Microsoft Excel, Numbers (for Mac OS X) or Calc (part of OpenOffice).

With the help of spreadsheets, individual statistical values can be clearly listed, edited, presented, saved and reloaded.

Connect the MiniTest FH to a PC using the “USB 2.0 A connector to Mini USB 2.0” cable that was supplied with the gauge and either in main menu or database menu press the function key “USB storage”. The following message is displayed: “The gauge now acts like a “standard” USB pen drive”. The Windows Explorer can now be used to copy the saved measurement series to the PC, where they can be saved and further processed.

This function is independent of the settings in the menus “Interfaces” and “Data output”.

Note: All measuring values and statistical values are stored in the data format that was previously set as described in section 10.6.1 “Data storage”: Measuring unit μm or mils, decimal separator comma or point. Installing a Windows driver is not required to use this function.

10. Main Menu



The main menu serves to create and configure the batches, configure the gauge, the connected sensor, the interfaces and the data output.

The service menu can also be accessed via the menu point to view the gauge and sensor characteristics.

Pressing the function key "USB Storage " causes MiniTest FH to behave like a USB mass storage device.

10.1 Database

Please refer to section 7.2

10.2 Batch configuration

The general parameters and the associated parameters for creating the statistics for the currently active batch are set in the main menu "Batch configuration".

The calibration for this batch can also be accessed via this configuration menu.



Use the arrow keys to select the submenu in which the settings are to be made and confirm with "OK" .

Target ball; see section 6.2.2

User

Data mode, see section 5.5.2 through 5.5.5

Logging rate, see section 5.5.3

Upper and lower limit, see section 8.1.1

Setpoint see section 8.1.2

Use the function key "Calibration" to open the calibration menu for this batch. Alternatively, the calibration menu for this batch can be accessed from measuring mode pressing the function key "Calibration".

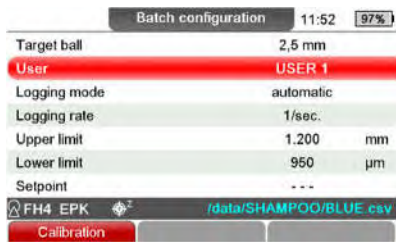

The name of the user of this batch can be entered in the batch configuration.

The input is carried out as described in section 4.6.4.

10.3 Gauge configuration

The submenu "Gauge configuration" serves to enter individual settings for the MiniTest FH wall thickness gauge.

Access the menu "Gauge configuration" via the main menu" and confirm with the "OK" key.

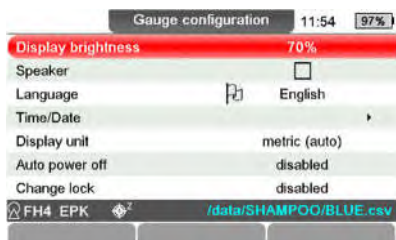

Use the arrow keys to select the submenu in which you want to make the settings and confirm with "OK" key.

10.3.1 Display brightness



The submenu "Display brightness" allows to modify the brightness of the backlight between 10% and 100%.

See also section 4.6.2. Setting selection parameters

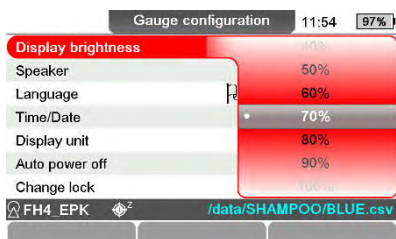

10.3.2 Speaker

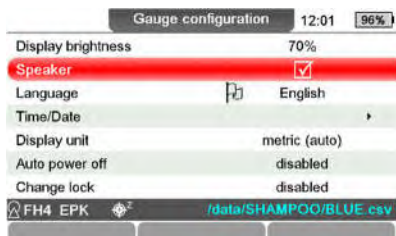

The internal signal transmitter of the MiniTest FH acknowledges a key press or acoustically signals when preset limits are exceeded.

This function can be switched on or off. Press the "OK" key to switch the state of this parameter for example to "ON" [x]. Press again to switch back to "off" [] and so on. The displayed status is also the selected status.

See also section 4.6.1

10.3.3 Language

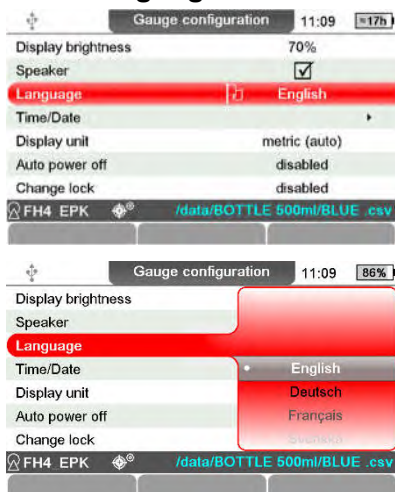

The operating language of the MiniTest FH can be set in this menu item, which is also identified by a flag symbol: Following languages are available: German, English, French, Swedish, Chinese. See also section 4.6.2.

10.3.4 Time/Date

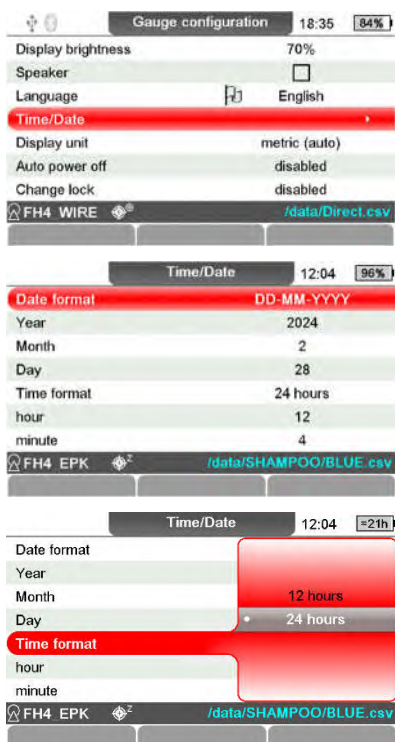

In the "Time/date" submenu, you can set the date and hour format, year, month, day, hour and minute (see chapter 4.6.2 Parameter settings).

The gauge features a quartz-controlled time clock. The current time is shown on the display in the top right-hand corner of the menu bar.

In conjunction with the data printer or a PC evaluation, the date and time of the last change to a measurement series and the print date are displayed. In addition, each measured value can be saved with a time stamp, see section 10.6.1 Data storage.

10.3.5 Display unit



The measuring values of the MiniTest FH can be displayed in the following measurement systems: metric auto, μm , mm, cm; imperial auto, mils, inch, thou. With the metric auto display mode, the display changes from μm to mm depending on the thickness; with the imperial auto display mode, the unit of measurement does not change depending on the wall thickness.

The "Display unit" setting only affects how the measured values are displayed in measurement mode and in the statistics and how they are printed out in the statistics overview.

The setting has no effect on the parameter:

- „Unit“ in „Data output,“Data storage“ for saved readings and
- „Unit“ for data output.

10.3.6 Auto power off

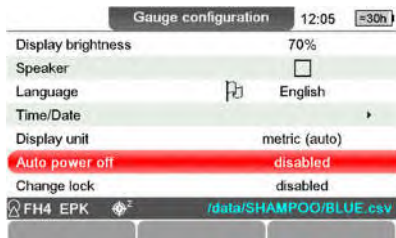

The MiniTest features an energy-saving mode that automatically switches the gauge off after an adjustable time interval if no further measurements or entries have been made up to that point.

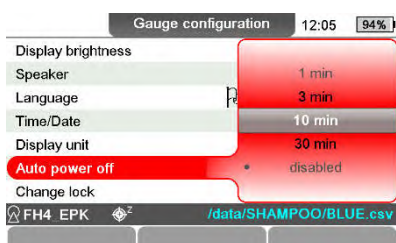

The switch-off time interval can be set between 1, 3, 10, 30 minutes or "off" (no automatic switch-off) in the "Automatic switch-off" submenu item. (See also section 4.6.2.). Before the MiniTest is switched off, the "Switch off gauge" prompt appears; switching off can be canceled within 10 seconds by pressing the "No" function key.

10.3.7 Change lock



You can assign a password for the Modification lock (pay attention to upper and lower case so that the modification lock will be password protected).



All entries are locked, measurement series can be selected, measured values can be recorded and the statistics can be viewed and printed out.

Note:

If the password has been forgotten, the password can be deactivated by entering the master password "Remove-PW". (see chapter 4.6.4 Setting alphanumeric parameters).

10.4 Sensor configuration



The menu point "Sensor configuration" offer settings to influence the properties of the SIDSP system that process the readings in the sensor. Furthermore, a new infinite value can be recorded using the "New infinite value" function key. As described in section 5.6.11,

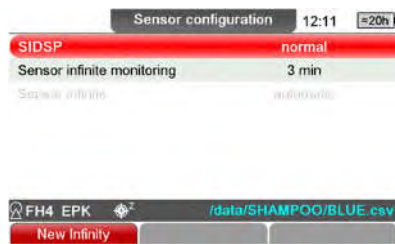

setting a new infinite value is useful to adjust the alignment of the sensor in a vertical or horizontal position.

Parameter: SIDSP

This parameter setting allows to influence the behavior of the sensor when displaying measuring values. Depending on the setting, optimization is carried out with regard to measurement speed or precision.

Option "normal":

This is the standard setting for normal measuring operation with medium measuring speed and medium precision.

Option "fast":

Here an increased measuring speed is used.

Option "precise":

Select this setting if the main focus is on maximum precision of the measured values and the measuring speed is a secondary consideration.

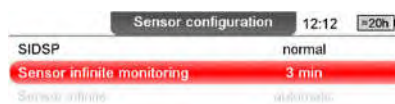
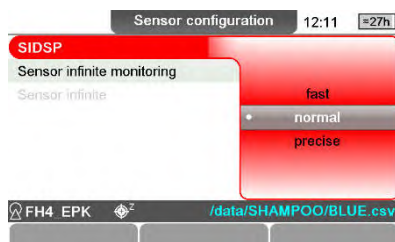

Monitoring of infinite value.

Each time the target ball is removed from the sensor tip in a distance of more than 30 mm, the gauge will automatically be adjusted to the infinite range. Any possible drift influences (e. g. through variations in temperature) will be extensively compensated. The more often the target ball is removed from the sample, the more often compensation will take place so as to increase measuring accuracy.

For that reason, it is recommended to lift the target ball from the sensor tip at least every three minutes. A message will appear on display accordingly to remind you to repeat infinite setting ("Refresh infinite Value !!!). The time for the reminder message to refresh the infinite value can be set from the default setting "3 min" to "5 min", "10 min" or deactivated "off".

Time intervals longer than 3 minutes should only be set if larger objects are to be measured that take longer than 3 minutes to measure. The gauge with the sensor should be switched on for a longer period of time and uniform temperature conditions should prevail. Infinite value monitoring should only be switched off for special applications such as online measurements. Special care

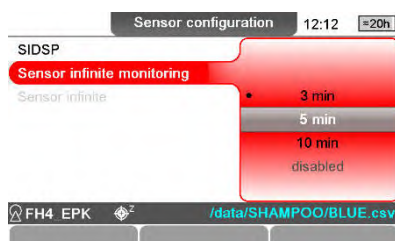

must be taken to ensure that stable temperature conditions prevail and that the measuring accuracy is also monitored in other ways. Even if monitoring of the infinite value is deactivated, the infinite value of the sensor is automatically adjusted as soon as the measurement object is moved away from the sensor.

10.5 Interfaces

The USB mode is set in the "Interfaces" main menu. In the "Bluetooth" menu item, the Bluetooth interface can be activated and MiniTest FH can be paired with a printer, and the foot switch actions and the switching outputs for signaling when limit values are exceeded or not reached are also assigned.

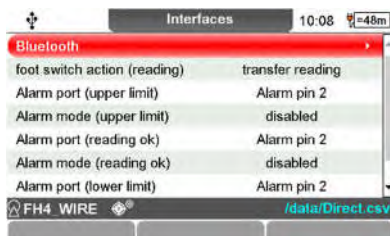

When MiniTest FH is connected to a Windows PC via USB for the first time, the system reports that a new hardware device has been detected and automatically installs the corresponding drivers. The default setting is "Device USB mode" COM port (VCP); other USB modes are currently not available. If the device USB mode is deactivated, no data is output via the USB interface; this affects the measured value output and the print output via the USB interface.

Bluetooth; active, inactive (preset).

Bluetooth printer; The paired printer is displayed here.



If no printer is paired yet, press the "OK" key. For this purpose, the Bluetooth interface must be active, the Bluetooth address of the switched-on data printer is displayed, this may take a few seconds.

If several Bluetooth printers are active, select the Bluetooth address of the requested printer and accept it by pressing the "OK" key".



Setting for the foot switch input (external switching contact):

- Setting = "delete" -> - delete the maximum and minimum values displayed in measuring mode
 - Setting = "transfer" -> In data mode "Act. Measured value", the displayed measuring value is transferred to the statistics

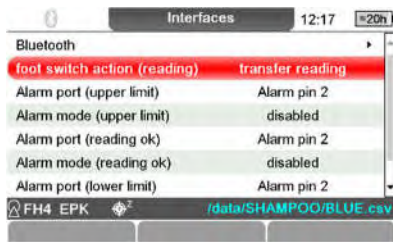

when the foot switch is pressed. In "Automatic" data mode, the value is transferred as long as the foot switch is pressed. An alarm signal is available for signaling when limit values are exceeded or not reached and for signaling measured values within the limit value range (measuring value OK). These can be assigned to the output contacts contact 2 on the foot switch socket, on the RS232 connection socket pin 2 or pin 3.

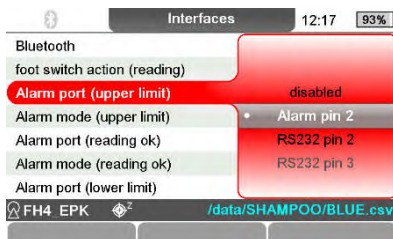

To further differentiate between the alarm signals, the length of the alarm can also be set.

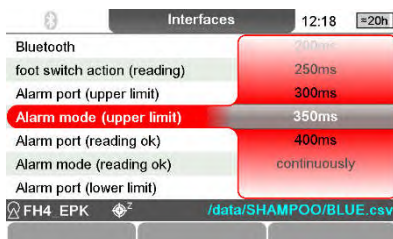

The following alarm settings are available: (off, 50ms, 100ms, 150ms, 200ms, 250ms, 300ms, 350ms, or 400ms, permanent signal).

10.6 Data output

The sub-menu "Data output" is used for parameter setting for saved data "Data storage" and for parameter settings for data transfer.

Note: Set the format of the saved measuring values before the first measurement in the "Data storage" submenu. The settings can only be made as long as no measuring values have been recorded.

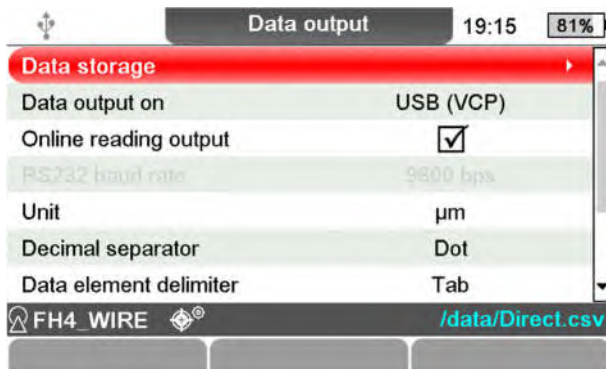

10.6.1 Data storage

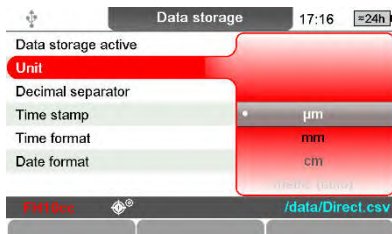

Data storage is active on delivery; it should only be set to inactive if no data is generally to be stored in the gauge, for example when MiniTest FH is permanently connected to a PC where documentation of measuring values is performed in a special software for quality assurance or controlling of production.

On delivery, measuring values are stored in μm and with a comma as decimal separator, for example:

268,0; μm ;Auto;27.04.2023;16:50:47

The decimal separator is important for transferring the .csv file with the measurement and statistical values to a spreadsheet program such as Microsoft® Excel® or quality assurance software.

Following settings are possible for the measuring unit: (μm , mm, cm, metric (auto), mils, inch thou, imperial (auto), nm.

Decimal separator: comma (preset), dot.

Time stamp: active (preset), inactive

Hour format: 24 (preset), 12 hours

Date format: DD-MM-JJJJ (preset), MM-DD-JJJJ

Note: The parameter settings in the "Data storage" menu have no influence on the screen format in the display and the format of data transmission via an interface.

10.6.2 Data output on...

MiniTest FH features a serial USB and an RS232 interface as well as a wireless Bluetooth interface. In factory settings, “Data output on“ is deactivated. For direct output of the measuring value during measurement, for example to transfer a measuring value to a processing system like a software for quality assurance (CAQ) or production control, select a corresponding interface:

- USB (VCP)
- RS232
- Bluetooth

Direct output of measuring values via the data output “Bluetooth printer“ is not possible.

10.6.2.1 Data output: Setting “USB“

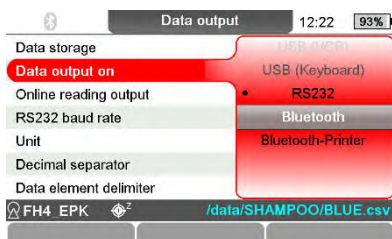

Connecting the MiniTest FH via USB is a quick and easy way to link the gauge to a PC. The required drivers are usually installed automatically on a Windows system.

Output of measuring values corresponds to the data format set as described in “10.6.2.5 Setting data format: Unit, Decimal separator, Data block limiter, Number of measuring value, Time stamp“ for example with data separator “semicolon”:

No. of reading	Measuring value	Unit	Time stamp
94;	271.0;	um;	04.05.2023; 1
			2
			:
			4
			5
			:
			5
			3

10.6.2.2 Data output: Setting “RS-232“

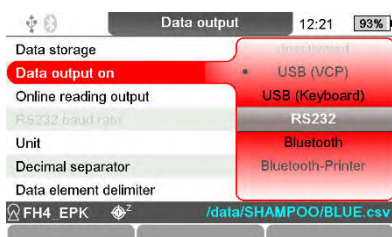

Direct transmission of measuring data can also be carried out via the serial RS-232 interface. This interface is often used in combination with multiplexers and industrial control systems. The optional RS232 cable is required for this purpose.

Transmission parameters must be configured identically in the MiniTest FH and the reception device.

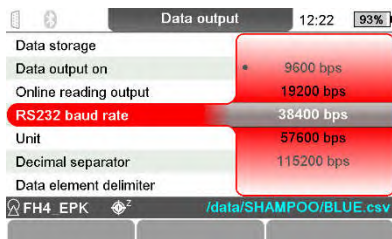

Depending on the requirements, the transmission speed can be set to the following values in the "RS232 baud rate" setting: 9600, 19200, 38400, 57600 or 115200.

The data format "8D/1S/N" (8 data bits, 1 stop bit, no parity) is fixed. The RS232 dialog box parameters can only be adjusted if the output has previously been to RS232.

10.6.2.3 Data output: Setting "Bluetooth"

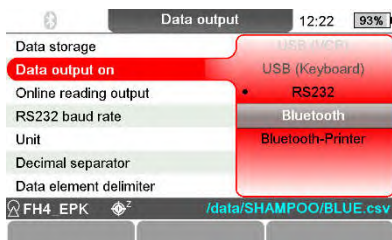

If data output is set to "Bluetooth", data transfer is performed wireless.

The Bluetooth setting is selected if the data (measuring and statistical values) are to be transferred to a PC with a Bluetooth interface.

10.6.2.4 Data output: Setting "Bluetooth printer"

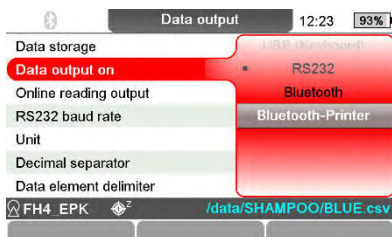

The Bluetooth setting is selected if the statistical data (measuring and statistical values) are to be printed out on a Bluetooth printer.

Bluetooth must be activated in the main menu Bluetooth and Bluetooth printer and the printer must be paired.

10.6.2.5 Setting data format: Unit, Decimal separator, Data block limiter, Number of measuring value, Time stamp



The measured values are provided according to the parameters set below:

for example using data separator "semikolon":

No. reading	of Measuring value	Unit	Time Date	stamp Time
94;	271.0;	um;	04.05.2023;	12:45:53



The "Unit" setting defines the data format of the measuring values transmitted via the interface. The following units can be set: µm (standard), mm, cm, metric (auto), mils, inch, thou, imperial (auto), nm.

In the metric (auto) and imperial (auto) settings, the data is transferred in "floating point" format, in the other units in "fixed point" format.

The "Decimal separator" setting can be set to point (default) or comma depending on regional conventions.

The "data separator" can be set to semicolon (default), tab and space.

"Data block end": CR Carriage Return (standard), LF Line Feed and CR+LF can be set.

"Output of the number of measuring value number": active (preset), - inactive.

"Output of time stamp": active (preset), inactive.

Description	No. of reading	Decimal separator	Measuring value	Separator	Unit	Carriage Return (CR)	Line Feed (LF)
Remarks	Only if the output of the reading number is activated	Semicolon	formatted right-aligned	Semicolon	um		
Example (hexadecimal Notation): Measuring value: 3;268,0;µm	0x33	0x3B	0x32 0x36 0x38 0x2E 0x30	0x3B	0x75 0x6D	0x0D	0x0A

10.7. Identification data

This submenu allows to visualize the gauge data Gauge data. Press the function key "Sensor" to visualize sensor data. Please have this data ready when contacting the service department.

Gauge data		Sensor data	
Model	MiniTest FH	Type	FH4_EPK
Serial number	000212	Serial number	115401
Hardware version	5	Hardware version	1.4
Software version	1.5	Software version	1.15
Build number	516	Build number	01
Flashdata version	1.6	Dataset version	1.07
Part number	80-190-0000	Part number	80-174-0000
Free disk space	7496MB		
Bluetooth			
Identifier	Gauge_000212		
Software version	V1.551		
FCC	RFRMSR		
IC	4957A-MSR		
MAC	008025D95D93		
FH4_EPK /data/SHAMPOO/BLUE.csv		FH4_EPK /data/SHAMPOO/BLUE.csv	
Sensor data		Gauge data	
Service		Service	

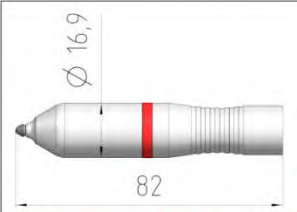

A service menu can be called up from the display of the device and sensor characteristics. To do this, press the "Service" function key 6 times in the corresponding display.

11. Service functions

11.1 Gauge service menu

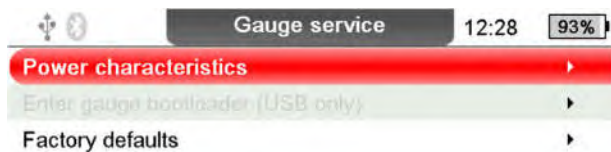

For access of the service menu, see 10.7 Identification data.

The charging status can be viewed via the "Power supply" submenu.

Call up bootloader (USB only) see section 11.3

Call up factory settings see section 11.2

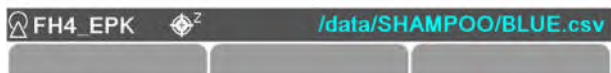
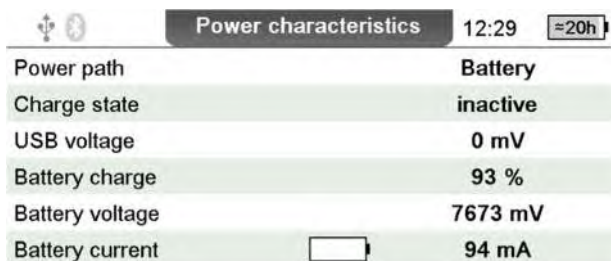
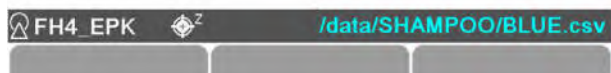

11.2 Total-Reset (Resetting to the factory settings

)

In case of unusual behaviour of the gauge as for example:

- No information messages
- Gauge does not switch off automatically
- Gauge does not allow any further measurements
- Keys without function
- illogical display values

Is the most likely solution a total reset!

All batches including their statistical, limit and calibration values are deleted. The basic settings are reset to the default settings.

Press the "ON-OFF" key simultaneously with the central function key and the arrow down key.



Alternatively, access the submenu Factory settings from the “Gauge service” menu and confirm the OK key .

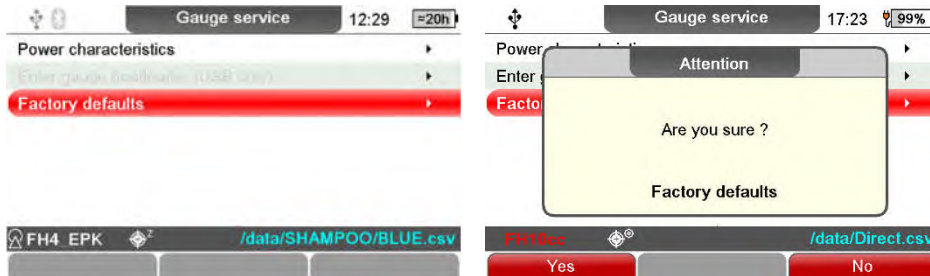

Attention !!

Confirming with function key “**YES**” will delete all data irretrievably. All settings are restored to factory settings.

All folders and batches including their measuring, statistical and calibration values are deleted.

In order to abort this process, press the function key “**NO**”.

11.Updating gauge firmware

For functional improvements and enhancements, MiniTest FH allows the installation of a firmware update. ElektroPhysik provides a software package for installation via a PC.

Start the Gauge_MTFH_UpdatePackage_Version_1.0 on your PC and the MiniTest FH Update Tool will open automatically and lead through the updating process.

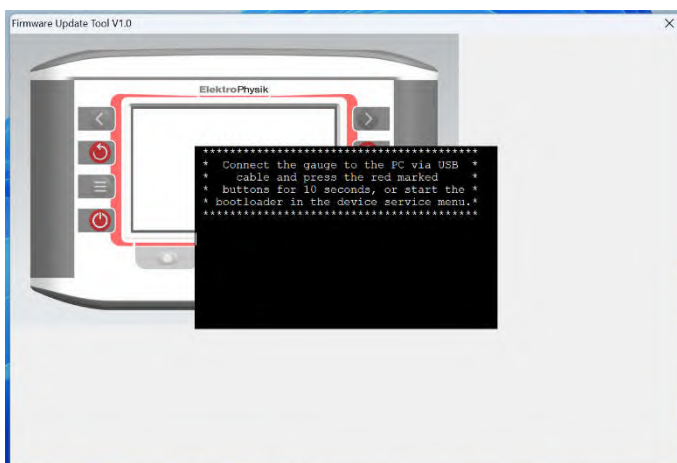

Connect the measuring device to the PC via USB cable and press the red marked keys for 10 seconds, or start the bootloader in the gauge service menu.

Starting the device boot loader from the gauge service menu (see 10.7 information data) .

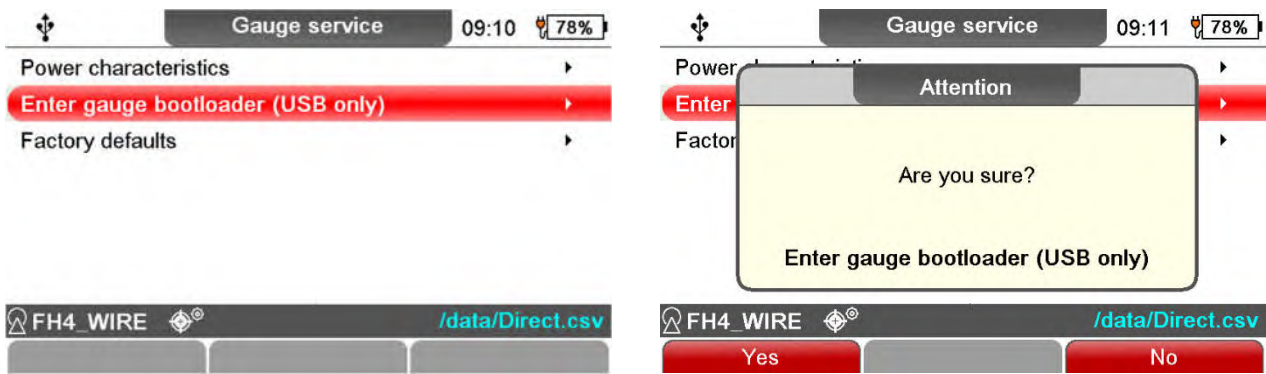

+

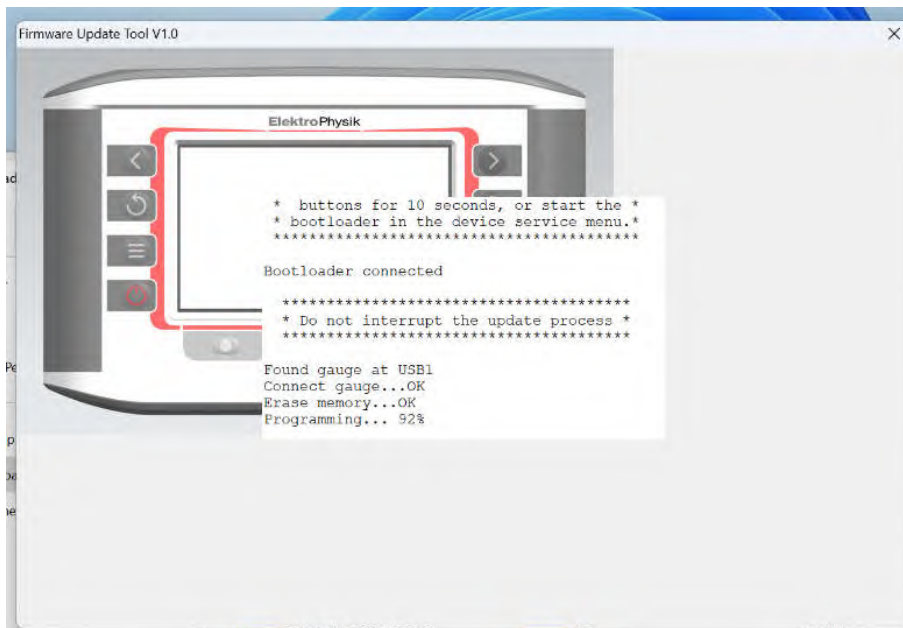

The update process will be launched. Do not interrupt the process afterwards. After completion, the following message appears: The update has been completed successfully. You can now close the program window. If necessary, restart the MiniTest FH.

12. Connectable accessories

12.1 General remarks

The MiniTest FH gauge feature a 7-pin multi-purpose socket for connecting various accessories directly or via a multi-purpose connection box.

12.2 Direct connection

This enables connection of one of the below accessorial devices. In addition, the plug-in mains-unit may be connected to the foot-switch.



RS 232C cable, cable with converter



foot-switch for storing readings into the statistics memory
incl. adapter unit for mains operation (see section 5.5.2-5.5.5).

An optical or acoustical alarm device may be connected to the alarm output

Electrical data:

voltage: 3.6 V

impedance: 330 Ohm

13. Care and Maintenance

13.1 Care

Use a soft damp cloth with water or a mild detergent to clean the gauge and accessories.

Use water or a mild household detergent.

Caution:

Do not use solvents because they might damage the plastic parts. Do not use metal brushes or other tools for cleaning the sensor tip.

13.1.1 Using NiMH storage batteries

The MiniTest FH is equipped with an LSD NiMH battery pack with low self-discharge. The battery is charged safely in the MiniTest FH with temperature monitoring. Charge the battery at an ambient temperature between 5 and 40°C. If a USB cable is connected to the MiniTest FH to supply the gauge with power via the mains adapter or a connected PC, a plug symbol is shown on the display combined with the battery symbol. This plug symbol indicates the charge status in color.



Red, charging is not possible, e.g. outside the temperature range.



Red with exclamation mark, charging is not possible due to a defective charging electronic



Orange, battery charging



Green, battery is fully charged

Observe the following instructions to increase the operating times and service life of the NiMH batteries:

If discharged batteries are left in the gauge for a longer period of time without charging them, this leads to critical damage to the cell's electrode (over-discharge) and shortens the battery's service life. So, this should be avoided.

Batteries should be recharged regularly, ideally when 70% of their capacity has been used up. This ensures that the batteries are not discharged too much, which is one of the main causes of damage to the cells.

Do not use batteries at high temperatures, as this increases the internal pressure in the cell, which leads to leakage and a shorter service life.

13.2 Maintenance

Generally, no maintenance work is required for MiniTest FH.

Please note:

Please note: Repairs may only be carried out by authorized ElektroPhysik staff.

14. Technical specifications

14.1 Gauge and Sensor Specifications

Measuring principle:	magneto-static principle, suitable for non magnetic materials
Measuring rate:	20 readings per second (factory set)
Number of readings to be logged for statistics:	1, 2, 5, 10 or 20 readings per second (user adjustable)

Sensor types:		FH2, FH4	FH10
Low range resolution:		0,1 µm	0,2µm
Display resolution	Ranges 0,0 µm – 59,9 µm 60,0 µm – 149,9 µm 150,0 µm – 299,5 µm 300,0 µm – 599,0 µm 600,0 µm – 998,0 µm 1,000 mm – 1,498 mm 1,500 mm – 2,995 mm 3,00 mm – 5,99 mm 6,00 mm – 24,00 mm	Resolution: 0,1 µm 0,2 µm 0,5 µm 1 µm 2 µm 2 µm 5 µm 10 µm 20 µm	Resolution 0,2 µm 0,2 µm 0,5 µm 1 µm 2 µm 2 µm 5 µm 10 µm 20 µm

H2 and FH2-90 Sensor					
Target ball Ø	Measuring range	Reproducibility	Tolerance:		
			Factory calibration:	Zero-point calibration	Multi-point calibration
1,5 mm	0 ... 0,6 mm	± (1,5 µm + 0,5%)*	± (10 µm + 3%)*	± (5µm + 1,5%)*	± (3µm + 1%)*
2,5 mm	0 ... 1,3 mm	± (2,5 µm + 0,5%)*	± (15 µm + 3%)*	± (8µm + 1,5%)*	± (5µm + 1%)*
4,0 mm	0 ... 2,3 mm	± (5 µm + 0,5%)*	± (30 µm + 3%)*	± (15µm + 1,5%)*	± (10µm + 1%)*

FH2_M and FH2_M-90 Sensor					
Target ball Ø	Measuring range	Reproducibility	Tolerance:		
			Factory calibration:	Zero-point calibration	Multi-point calibration
1,5 mm	0 ... 0,6 mm	± (1,5 µm + 0,5%)*	± (10 µm + 3%)*	± (6µm + 1,5%)*	± (5µm + 1%)*
2,5 mm	0 ... 1,3 mm	± (2,5 µm + 0,5%)*	± (15 µm + 3%)*	± (10µm + 1,5%)*	± (6µm + 1%)*
4,0 mm	0 ... 2,3 mm	± (5 µm + 0,5%)*	± (30 µm + 3%)*	± (15µm + 1,5%)*	± (10µm + 1%)*
1M5 mm magnetized steel ball	0 ... 2,0 mm	± (10µm + 1%)*	-	± (30µm + 3%)*	± (20µm + 2%)*
3M0 mm magnetized steel ball	0 ... 4,5 mm	± (20µm + 1%)*	-	± (60µm + 3%)*	± (40µm + 2%)*

FH4 and FH4-90 Sensor					
Target ball Ø	Measuring range	Reproducibility	Tolerance:		
			Factory calibration:	Zero-point calibration	Multi-point calibration
1,0 mm (Option)	0 ... 1,3 mm	$\pm (1,5 \mu\text{m} + 0,5\%)*$	$\pm (10 \mu\text{m} + 3\%)*$	$\pm (5\mu\text{m} + 1,5\%)*$	$\pm (3\mu\text{m} + 1\%)*$
1,5 mm	0 ... 2,0 mm	$\pm (1,5 \mu\text{m} + 0,5\%)*$	$\pm (10 \mu\text{m} + 3\%)*$	$\pm (5\mu\text{m} + 1,5\%)*$	$\pm (3\mu\text{m} + 1\%)*$
2,5 mm	0 ... 3,5 mm	$\pm (2,5 \mu\text{m} + 0,5\%)*$	$\pm (15 \mu\text{m} + 3\%)*$	$\pm (8\mu\text{m} + 1,5\%)*$	$\pm (5\mu\text{m} + 1\%)*$
4,0 mm	0 ... 6,0 mm	$\pm (5 \mu\text{m} + 0,5\%)*$	$\pm (30 \mu\text{m} + 3\%)*$	$\pm (15\mu\text{m} + 1,5\%)*$	$\pm (10\mu\text{m} + 1\%)*$

FH4_M Sensor					
Target ball Ø	Measuring range	Reproducibility	Tolerance:		
			Factory calibration:	Zero-point calibration	Multi-point calibration
1,5 mm	0 ... 2,0 mm	$\pm (1,5 \mu\text{m} + 0,5\%)*$	$\pm (10 \mu\text{m} + 3\%)*$	$\pm (5\mu\text{m} + 1,5\%)*$	$\pm (3\mu\text{m} + 1\%)*$
2,5 mm	0 ... 3,5 mm	$\pm (2,5 \mu\text{m} + 0,5\%)*$	$\pm (15 \mu\text{m} + 3\%)*$	$\pm (8\mu\text{m} + 1,5\%)*$	$\pm (5\mu\text{m} + 1\%)*$
4,0 mm	0 ... 6,0 mm	$\pm (5 \mu\text{m} + 0,5\%)*$	$\pm (30 \mu\text{m} + 3\%)*$	$\pm (15\mu\text{m} + 1,5\%)*$	$\pm (10\mu\text{m} + 1\%)*$
1M5 mm Magnetic ball	0 ... 5,0 mm	$\pm (10\mu\text{m} + 1\%)*$	-	$\pm (30\mu\text{m} + 3\%)*$	$\pm (20\mu\text{m} + 2\%)*$
3M0 mm Magnetic ball	0 ... 9,0 mm	$\pm (20\mu\text{m} + 1\%)*$	-	$\pm (60\mu\text{m} + 3\%)*$	$\pm (40\mu\text{m} + 2\%)*$

FH10 Sensor					
Target ball Ø	Measuring range	Reproducibility	Tolerance:		
			Factory calibration:	Zero-point calibration	Multi-point calibration
2,5 mm	0 ... 4,0 mm	$\pm (2,5 \mu\text{m} + 0,5\%)*$	$\pm (15\mu\text{m} + 3\%)*$	$\pm (8\mu\text{m} + 1,5\%)*$	$\pm (5\mu\text{m} + 1\%)*$
4,0 mm	0 ... 7,0 mm	$\pm (5 \mu\text{m} + 0,5\%)*$	$\pm (30\mu\text{m} + 3\%)*$	$\pm (15\mu\text{m} + 1,5\%)*$	$\pm (10\mu\text{m} + 1\%)*$
6,0 mm	0 ... 10 mm	$\pm (10 \mu\text{m} + 0,5\%)*$	$\pm (50\mu\text{m} + 3\%)*$	$\pm (30\mu\text{m} + 1,5\%)*$	$\pm (20\mu\text{m} + 1\%)*$
9,0 mm	0 ... 13 mm	$\pm (10 \mu\text{m} + 0,5\%)*$	$\pm (50\mu\text{m} + 3\%)*$	$\pm (30\mu\text{m} + 1,5\%)*$	$\pm (20\mu\text{m} + 1\%)*$
		*All percentages are related to the measuring value. Measurement on horizontal surfaces, mean value calculated from a minimum of 10 readings			

FH10_M Sensor					
Target ball Ø	Measuring range	Reproducibility	Tolerance:		
			Factory calibration:	Zero-point calibration	Multi-point calibration
2,5 mm	0 ... 4,0 mm	$\pm (2,5 \mu\text{m} + 0,5\%)*$	$\pm (15\mu\text{m} + 3\%)*$	$\pm (8\mu\text{m} + 1,5\%)*$	$\pm (5\mu\text{m} + 1\%)*$
4,0 mm	0 ... 7,0 mm	$\pm (5 \mu\text{m} + 0,5\%)*$	$\pm (30\mu\text{m} + 3\%)*$	$\pm (15\mu\text{m} + 1,5\%)*$	$\pm (10\mu\text{m} + 1\%)*$
6,0 mm	0 ... 10 mm	$\pm (10 \mu\text{m} + 0,5\%)*$	$\pm (50\mu\text{m} + 3\%)*$	$\pm (30\mu\text{m} + 1,5\%)*$	$\pm (20\mu\text{m} + 1\%)*$
9,0 mm	0 ... 13 mm	$\pm (10 \mu\text{m} + 0,5\%)*$	$\pm (50\mu\text{m} + 3\%)*$	$\pm (30\mu\text{m} + 1,5\%)*$	$\pm (20\mu\text{m} + 1\%)*$
4M0 mm Magnetic ball	0 ... 16 mm	$\pm (20\mu\text{m} + 1\%)*$	-	$\pm (60\mu\text{m} + 3\%)*$	$\pm (40\mu\text{m} + 2\%)*$

6M0 Magnetic ball	mm 0 ... 24 mm	$\pm (30\mu\text{m} + 1\%)*$	-	$\pm (80\mu\text{m} + 3\%)*$	$\pm (60\mu\text{m} + 2\%)*$
* All percentages refer to the measuring value. Measurement on a horizontal surface, average of at least 10 individual values.					

Calibration modes:	Factory calibration, Zero point calibration and multi-point calibration ((Zero plus 1 to 4 calibration points)
Display:	4,3" TFT/LCD 800x480 with adjustable lighting
Measuring system:	metric (μm , mm), imperial (mils) or (decimal inch) (fixed comma format)
Statistics functions:	Single readings, number of readings, min, max, average, standard deviation, variation coefficient and process capability indices Cp and Cpk (only available with MiniTest FH)
Data memory	> 2.000.000 readings
Max number of folders	5 folder levels
Maximum number of batches:	200
Monitoring of limit values	Display and acoustic alert, labeling for the measuring value in statistics
Differential mode:	Display of the difference between current reading and pre-set set point
Statistics:	numerical, histogram, trend diagram
Languages:	English, German, French, Swedish, Polish
Interfaces:	Bluetooth, RS232 TTL, USB for data transfer and power supply during operation or for battery charging, multi-functional socket for foot switch and alarm output, ,
Operating temperature:	-10°C to + 60°C
Storage temperature:	-20°C to + 70°C
Protection class of gauge housing:	IP 65
Dimensions and weight of gauge:	194 mm x 121 mm x 44 mm / 760 g including battery pack
Dimensions and weight of FH 4 sensor:	\varnothing 17 mm x 96 mm / 90 g
Dimensions and weight of FH 10 sensor:	\varnothing 30 mm x 125 mm / 300 g
Dimensions of plastics carrying case:	365 mm x 450 mm x 140 mm
Operating time:	Battery life in continuous mode approx. 22 hours or 40 hours in powersafe mode.
Power supply:	Internal rechargeable battery 7,2 V 2700 mAh, Mains unit (100 to 240V AC / 50-60Hz Output 5VDC 2A)

14.2 Delivery Scope

14.2.1 Wall thickness gauge MiniTest FH

Description	SKU
Wall thickness gauge MiniTest FH for non-magnetic materials Gauge without sensor	80-190-0000
Delivery scope: Basic unit complete with plastic carrying case, mains unit, USB connection cable	

14.2.2 Sensors

Description	SKU
FH4 FH4-90 FH4cc FH4cc-90 including shielding tube, probe stand, one precision standard approx. 0.25 mm, 1 mm and 3 mm, one zero standard for ball dia. 1.5 mm, 2.5 mm and 4 mm. 100 balls each dia. 1.5 mm and 2.5 mm, 50 balls dia. 4 mm, manufacturer's certificate DIN 55350 M	80-174-0600 80-174-1000 80-174-0650 80-174-1050
FH4-1 FH4-1-90 Additional feature: measurement with 1 mm dia. steel balls including shielding tube, probe stand, one precision standard approx. 0.15 mm, 0.25 mm, 1 mm and 3 mm, one zero standard for ball dia. 1mm, 1.5 mm, 2.5 mm and 4 mm. 100 balls each in dia. 1 mm, 1.5 mm and 2.5 mm, 50 balls dia. 4 mm, manufacturer's certificate DIN 55350 M	80-174-0300 80-174-1100
FH4-M FH4-M-90 FH4cc-M FH4cc-M-90 Additional feature: increased range/ modified for magnetic balls including shielding tube, probe stand, one precision standard approx. 0.25 mm, 1 mm, 3 mm and 8 mm, one zero standard for ball dia. 1.5 mm, 2.5 mm, 3 mm and 4 mm. 100 balls dia. 1.5 mm and 2.5 mm, 50 balls dia. 4 mm, 25 magnetic balls dia. 1.5 mm, 20 magnetic balls dia. 3 mm. Manufacturer's certificate DIN 55350 M.	80-174-0500 80-174-1200 80-174-0510 80-174-1250
FH-4-WIRE SIDSP® FH4-WIRE-90 incl. protective cap, shielding tube, probe stand, 1 precision standard approx. 1 mm, 3 mm and 8 mm, 1 zero standard for wire dia. 0.66 mm and 1.15 mm each, 20 measuring wires in dia. 0.66 mm and 1.15 mm each, manufacturer's certificate.	80-174-0050 80-174-1300
FH2 FH2-90 incl. protective cap, shielding tube, probe stand, 1 precision standard approx. 0.25 mm, 0.5 mm and 1,5 mm, 1 zero standard for ball dia. 1.5 mm, 2.5 mm and 4 mm, 100 balls each in dia. 1.5 and 2.5 mm, 50 balls in dia 4 mm, manufacturer's certificate incl. protective cap, shielding tube, probe stand,	80-178-0000 80-178-0100

FH2-M FH2-M-90 incl. protective cap, shielding tube, probe stand, 1 precision standard approx. 0.25 mm, 0.5 mm and 1,5 mm, 1 zero standard for ball dia. 1.5 mm, 2.5 mm and 4 mm, 100 balls each in dia. 1.5 and 2.5 mm, 50 balls in dia 4 mm, manufacturer's certificate incl. protective cap, shielding tube, probe stand,	80-178-0200 80-178-0300
FH10 FH10cc incl. protective cap, shielding tube, probe stand, one precision standard approx. 1 mm, 3 mm and 8 mm, one zero standard for ball dia. 2.5 mm, 4 mm, 6 mm and 9 mm. 100 balls in dia. 2.5 mm, 50 balls dia. 4 mm, 25 balls dia. 6 mm, 10 balls dia. 9 mm, manufacturer's certificate	80-174-0900 80-174-1400
FH10-M FH10cc-M <u>Additional feature: increased range/ modified for magnetic balls</u> incl. protective cap, shielding tube, probe stand, one precision standard approx. 1 mm, 3 mm, 8 mm and 18 mm, one zero standard for ball dia. 2.5 mm, 4 mm, 6 mm and 9 mm. 100 balls in dia. 2.5 mm, 50 balls dia. 4 mm, 25 balls dia. 6 mm, 10 balls dia. 9 mm, 20 magnetic balls dia. 4 mm, 20 magnetic balls dia. 6 mm, manufacturer's certificate	80-175-0600 80-174-1500

14.3 Accessories

Description	SKU
RS 232C cable for MiniTest FH	82-190-0002
Foot switch for MiniTest FH	80-901-1901
Universal connection box for MiniTest FH	80-190-0003
Interchangeable cap for FH4cc and FH4cc-M	82-174-0082
Interchangeable cap for FH10cc and FH10cc-M	82-175-0069
<u>Spare parts</u>	
Plastic carrying case	08-038-0027
USB-extension\A - A\1,8m AWG20 Power strands\Black	02-059-0011
USB-Adapter\OTG\16cm cable / Mini-USB Stecker*USB- A socket	02-020-0045
<u>Accessories for sensor FH4</u>	
Set of standards for steel ball Ø 1,0mm 1 zero calibration cap for steel balls Ø 1,0mm, 100 steel balls Ø 1,0mm	82-174-0014

Set of standards for 5-point calibration/ FH4 probe and ball diam 1,5 mm: 1 precision standard in approx. 0.15 mm, 0.25 mm, 0.43 mm, 0.75 mm and 1.3 mm	82-174-0010
Set of standards for 5-point calibration/ FH4 probe and ball diam. 2.5 mm: 1 precision standard in approx. 0.25 mm, 0.43 mm, 0.75 mm, 1.3 mm and 2.2 mm	82-174-0011
Set of standards for 5-point calibration/ FH4 probe and ball diam. 4 mm: 1 precision standard in approx. 0.43 mm, 0.75 mm, 1.3 mm, 2.2 mm and 3.6 mm	82-174-0012
Manufacturers certificate (DIN 55350 M) for precision standards	
Manufacturers certificate (DIN 55350 M) for a set of precision standards for multipoint calibration	
<u>Spare parts for sensor FH4</u>	
Measuring support for FH4 spring-mounted (delivery scope)	70-174-0015
Zero calibration cap/ 1.5 mm for FH4	82-174-0024
Zero calibration cap/ 2.5 mm for probe FH4	82-174-0025
Zero calibration cap/ 4.0 mm for probe FH4	82-174-0026
Calibration cap FH4/ 300 µm	82-174-0020
Calibration cap FH4/ 1mm	82-174-0021
Calibration cap FH4/ 3 mm	82-174-0023
Calibration cap FH-4/ 8 mm (use with magnet balls)	82-174-0028
Steel balls 1.5 mm (price per 100 pieces)	82-174-0004
Steel balls 2.5 mm (price per 100 pieces)	82-175-0004
Steel balls 4.0 mm (price per 50 pieces)	82-175-0005
Magnetic balls 1.5 mm (price per 25 pieces)	82-174-0029
Magnetic balls 3 mm (price per 20 pieces)	82-174-0030
<u>Accessories for sensor FH10</u>	
Set of standards for 5-point calibration/ FH10 probe and ball diam. 2.5 mm: 1 precision standard in approx. 0.25 mm, 0.43 mm, 0.75 mm, 1.3 mm and 2.2 mm	82-175-0020
Set of standards for 5-point calibration/ FH10 probe and ball diam. 4 mm: 1 precision standard in approx. 0.43 mm, 0.75 mm, 1.3 mm, 2.2 mm and 3.6 mm	82-175-0017

Set of standards for 5-point calibration/ FH10 probe and ball diam. 6 mm: 1 precision standard in approx. 1.0 mm, 1.7 mm, 3.0 mm, 5.2 mm and 9.0 mm	82-175-0010
Set of standards for 5-point calibration/ FH10 probe and ball diam. 9 mm: 1 precision standard in approx. 1.0 mm, 1.7 mm, 3.0 mm, 5.2 mm and 9.0 mm	82-175-0037
Manufacturers certificate (DIN 55350 M) for precision standards	
Manufacturers certificate (DIN 55350 M) for a set of precision standards for multipoint calibration	
Measuring support for FH10 spring-mounted (delivery scope)	70-175-0014
Zero calibration cap/ 2.5 mm for FH-10	82-175-0033
Zero calibration cap/ 4.0 mm for FH-10	82-175-0034
Zero calibration cap/ 6.0 mm for FH-10	82-175-0035
Zero calibration cap/ 9.0 mm for FH-10	82-175-0036
Calibration cap FH10/ 1 mm	82-175-0030
Calibration cap FH10/ 3 mm	82-175-0031
Calibration cap FH10/ 8 mm	82-175-0032
Calibration cap FH10/ 18 mm (use with magnet balls)	82-175-0039
Steel balls 2.5 mm (price per 100 pieces)	82-174-0004
Steel balls 4.0 mm (price per 50 pieces)	82-175-0005
Steel balls 6.0 mm (price per 25 pieces)	82-175-0006
Steel balls 9.0 mm (price per 10 pieces)	82-175-0014
Magnetic balls 4 mm (price per 20 pieces)	82-175-0023
Magnetic balls 6 mm (price per 20 pieces)	82-175-0024
Manufacturers certificate (DIN 55350 M) for precision standards	
Manufacturers certificate (DIN 55350 M) for a set of precision standards for multipoint calibration	

15. Appendix

15.1 Troubleshooting

Error Message	Problem	Remedy
Battery almost empty. Please recharge.	The internal battery is almost empty. You can continue to work for a certain amount of time, but you should operate the device with the USB plug-in power supply and charge the internal battery at the same time. The device switches off automatically if the voltage falls below a minimum level.	Operate the MiniTest with the USB plug-in power supply and charge the internal battery at the same time.
Sensor not in infinite range. Please check that there is no metal near the sensor head.	a) Are protection tube and protection cap removed from the sensor? b) Is a target ball sticking to the sensor tip? c) Is the sensor tip in contact with a ferrous object? (see also section 6.1)	a) Remove the protective tube and/o protection cap b) Remove the target ball c) Place the sensor in a larger distance to ferrous objects. <i>When the error message is no longer shown, the sensor is ready to measure.</i>
Refresh infinite value !!! (The infinite value should be actualized)	To ensure the guaranteed measuring accuracy, the infinite value must be refreshed. See also section 6.1	Remove target ball from sensor. If the message persists, please press Refresh function key. During a measurement you can press ESC in order to cancel the Refresh procedure.
Sensor doesn't match current measurement series. Delete all existing data in order to take readings in the this	Data from another sensor type is stored in the active batch .. Data from another sensor is stored in the active batch.	Select or create another batch. You can select another batch, create a new measurement series or record new measuring

Error Message	Problem	Remedy
<p>measurement series?</p> <p>Delete all readings?“</p>		<p>values by deleting the measuring values in the measurement series.</p> <p>Cancel by pressing the "No" function key. The measuring values are deleted with "Yes ".</p> <p>.</p>
<p>Please check for correct target ball size!</p>	<p>You have probably selected a wrong target ball.</p>	<p>Make sure the adjusted target ball size matches the target ball used for measurement.</p>
<p>Please check sensor and target ball position!</p>	<p>Make sure there is not target ball positioned laterally to the sensor tip. Make sure to keep the sensor out off the influence of ferrite objects or magnetic fields.</p>	<p>Remove target ball from sensor. Keep away from ferrite objects or magnetic fields.</p>
<p>Sensor disconnected!</p>	<p>The sensor plug was removed while the gauge was switched on or the connection to the sensor was interrupted.</p> <p>Possible cause:</p> <ul style="list-style-type: none"> ▪ no sensor connected ▪ loose probe connection ▪ damaged cable <p>defective sensor</p>	<p>Please check the options. If the sensor is defective, please change it or contact after sales service.</p>

15.2 Possible interferences affecting the measuring process

Measurement may be influenced by static or alternating magnetic fields and by metallic objects near the sensor.

If no target ball is placed on the sensor, "INF" will be shown on the display next to the steel ball. That means that the probe is in the infinity range.

Make sure that INF is **shown** so that **correct** readings can be taken.

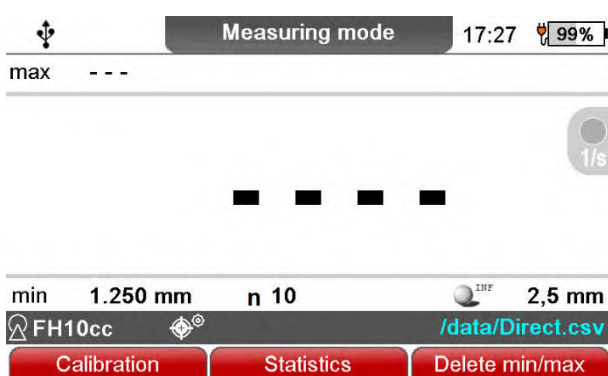

If the sensor is subject to some interference (e.g. through electro-motors, transformers, potential distribution or if a steel plate is near the sensor) INF **disappears**.

The measurement is also disturbed if the sensor is placed on a steel plate.

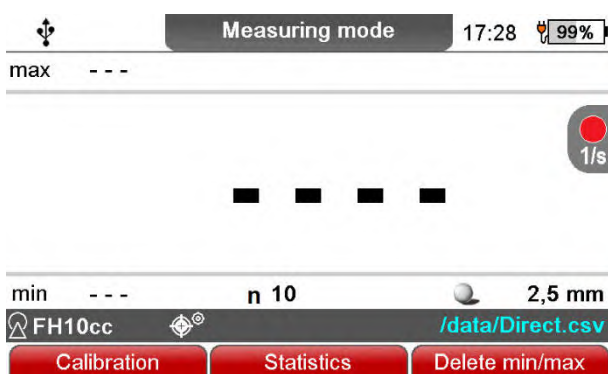

Try to move the sensor a little bit in order to locate the source of interference. If you have detected the error source, move the sensor away from it. As soon as "INF" appears on display, the sensor is out of the error source range and the gauge is ready again to take correct measurements.

To be sure, double the distance from the error source.

15.3 Statistical Terms

The statistical evaluation should help to better assess measurements and make a more reliable decision about the quality of the tested material.

Average (Mean)

The sum of single readings divided by the total number of readings.

$$\bar{x} = \frac{\sum x}{n}$$

Standard Deviation s (STD.-DEV.)

The sample standard deviation is a statistic that measures how “dispersed“ the sample is around the sample mean. The sample standard deviation increases with increasing spread out. The standard deviation of a set of numbers is the root mean square of the variance s^2 .

$$s^2 = \frac{\sum(x - \bar{x})^2}{n-1}$$

$$s = \sqrt{s^2}$$

Variance

The variance of a list is the square of the standard deviation of the list, that is, the average of the squares of the deviations of the numbers in the list from their mean divided by the (number of readings minus 1).

Variation coefficient (Var.-coeff.)

The variation coefficient is the standard deviation divided by the arithmetic mean. The variation coefficient is indicated in percent.

$$K \text{ var} = \frac{s}{\bar{x}} \times 100\%$$

Process capability index (Cp)

The cp index is a measure of the spread of the readings as related to the specification limits. Only the spread is of importance here. The cp index is calculated as follows:

$$C_p = \frac{OSG - USG}{6s}$$

LSL = Lower set limit (Low-Limit)

USL = Upper set limit (High-Limit)

Process capability index (Cpk)

In addition to the spread, the **cpk** index also takes into account the location of midpoint as related to the specification limits.

$$C_{pku} = \frac{\bar{x} - USG}{3s}$$

$$C_{pko} = \frac{OSG - \bar{x}}{3s}$$

$$C_{pk} = \text{Min} \{ C_{pku}, C_{pko} \}$$

15.4 Safety Notes

Safe operation will be ensured as far as the instructions and notes in this manual and/or gauge will be observed.

For installation work, please cut the power supply. Use only original spare parts and/or accessories.

If not in use, the sensor must always be stored with the protection tube put on it.



Risk through exposure to magnetic fields

Within a distance of 15 cm, the sensor creates static magnetic fields of up to 1 mTesla.



Pacemakers

Patients with heart pacemakers should consult their doctor to clarify whether using the magnetic sensor may imply any health risk for them.



Magnetic data carriers

The magnetic field created by the sensor may impair the operability of magnetic data carriers, electronic devices and all kinds of encoded magnetic media. Do not place the sensor alongside computer disks, credit cards, travel cards and other magnetic media. The information contained on disks or cards may be affected by the sensor. Make sure to keep a safety distance of at least 30 cm.



Keep away from monitors and electronic devices

The magnetic field created by the sensor may impair the operability of computer or video monitors, electronic devices and measuring gauges or even destroy them. Make sure to keep a safety distance of at least 20 cm from such devices.



Keep away from watches and metallic parts

The static magnetic field created by the sensor may magnetize watches or other metallic parts. Make sure to keep a safety distance of at least 20 cm from such items.



Risk of injury

Within a distance of 15 cm, the sensor creates static magnetic fields of up to 1 mTesla. Keep a safety distance of at least 15 cm in order to avoid injury through metallic parts being attracted by the sensor.



Risk of injury through metallic splinters

The magnetic field may attract metal parts damaging the hard metal sensor tip. Through the impact, the hard metal housing of sensor might go into splinters.



Storage batteries and accessories

Make sure to use only original accessories and batteries supplied/recommended by the manufacturer of gauge. Connect only to compatible peripheral devices.



Connecting other devices

If you connect the gauge to another device as recommended by the manufacturer, please refer to the corresponding instruction manual for detailed information on safety issues. Do only connect original accessories recommended by the manufacturer of the MiniTest FH.



Keep away from water

The measuring unit is not waterproof. Keep in a dry place.



Keep away from explosion-hazardous area



Approved after-sales service

The gauge may only be repaired by approved and qualified after-sales service personnel.



Medical facilities

Please ask for permission before using the gauge in medical facilities.

15.5 Declaration of Conformity

We, ElektroPhysik Dr. Steingroever GmbH & Co. KG, Pasteurstr. 15, 50735 Cologne, Germany, declare in sole responsibility that the products MiniTest FH to which this declaration relates are in conformity with the provisions of EU directive

2014/30/EU (electromagnetic compatibility) dated February 26, 2014

2011/65/EU (RoHS) dated June 8, 2011

2012/19/EU (WEEE) dated July 4, 2012 registration number 66544799

15.6 Return of old equipment

For the treatment and recycling of old appliances in accordance with EU Directive 2012/19/EU (WEEE) of July 4, 2012 implemented by the 2015 amendment to the German Electrical and Electronic Equipment Act (ElektroG2), please send the MiniTest FH to the manufacturer:

ElektroPhysik

Dr. Steingroever GmbH & Co. KG

Pasteurstr. 15

D-50735 Köln

Germany

15.7 After-Sales service

MiniTest FH instruments and sensors are manufactured using high-quality components and state-of-the-art methods. Careful interim inspections and a quality management system certified to DIN EN ISO 9001 ensure that the gauge is manufactured to the highest quality standards.

Should you notice a fault with your instrument, please contact the responsible ElektroPhysik customer service department, supplying a description of the fault.

Please note that the gauge should only be repaired by authorized, skilled and trained personnel. Service attempts by untrained personnel could cause extensive damage to the gauge and possibly void any warranties.

Keep the shipping packaging for any repairs that cannot be carried out on site. In the event of repairs, always ship the sensors housed in the shielding tube to avoid damage during transportation and not expose the shipping company to strong magnetism!

If you have any specific questions about the application, use, operation or specification of the wall thickness gauge MiniTest FH, please contact your local ElektroPhysik representative or contact us directly:

Germany

ElektroPhysik
Dr. Steingroever GmbH & Co. KG
Pasteurstr. 15
50735 Köln

Tel.: +49 221 75204-0

Fax: +49 221 75204-69

E-Mail: info@elektrophysik.com

16. Index

B

Batch · 46, 84, 85

Batteries · 39

Battery

charging status · 20

Bluetooth wireless interface · 55

C

Calibration

Factory calibration · 40

Factory preset · 12

Multi-point calibration · 40

Quick calibration · 40

Zero calibration · 40

Calibration

Factory preset · 11

Calibration

Calibration methods · 12

Calibration

Calibration method · 41

Calibration

Calibration method · 41

Configuration · 28, 32, 33, 46, 48, 50

D

Data · 70, 72, 84

Data output on interface · 67

Direct Mode · 11

F

Folder · 72

Folders

Creation · 48

Function keys · 14

G

Gauge data · 70

H

Histogram · 50, 57

I

Initial start-up · 11

Interfaces · 56

L

Limits · 21, 50

M

Main menu · 24, 48, 52, 60

Mains adapter · 15

Maximum · 52

Measuring mode · 20, 21, 48

Measuring value · 20

Measuring values · 11, 52, 55

N

Numerical input · 26

P

Parameter settings · 32
Parameter settings · 46
Power supply · 15
precision standard · 43
Precision standard · 40
Preset set point · 20

Q

Quick calibration · 41

R

Rechargeable batteries · 15

S

Sensor data · 70
Set point · 46
Status line · 12
Steel ball diameter · 12, 41

T

Trend diagram · 50, 57

U

USB Storage · 59

Z

Zero calibration · 40, 41