

# DT-5TXR / DT-5TS

DIGITAL PANEL MOUNT TACHOMETER

## Instruction Manual

# DT-5TXR/DT-5TS

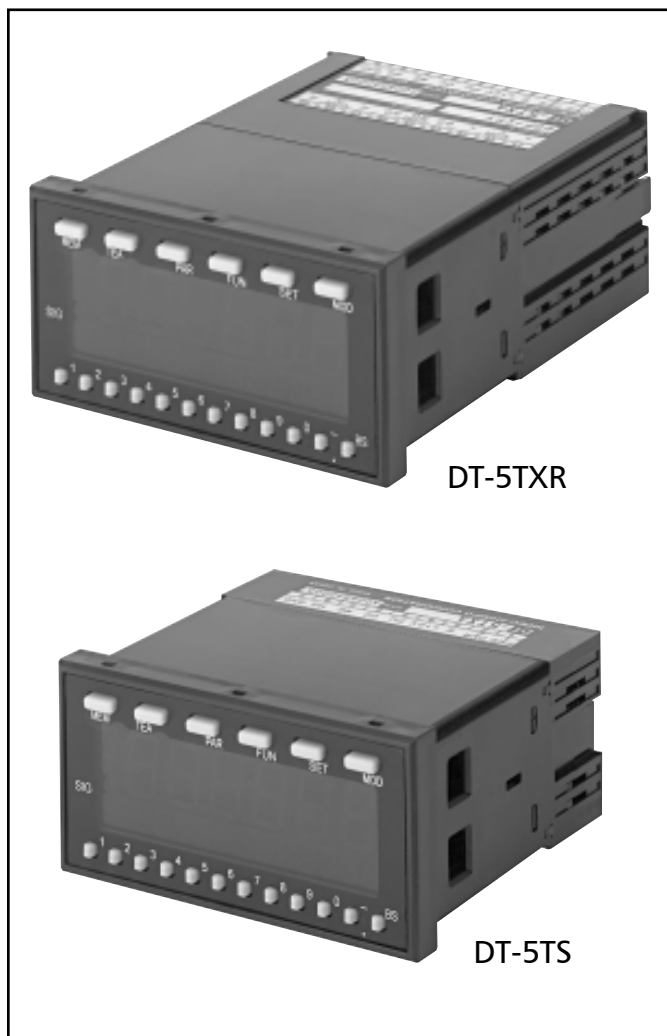

DT-5TXR

DT-5TS

Congratulations on your purchase of a Shimpo DT-5TXR or DT-5TS digital panel mount tachometer. Whether measuring RPM or a complex function, we trust you will enjoy many years of professional results.

Please read the entire instruction manual thoroughly before initial set-up and operation; the information contained herein will aid in operating your Shimpo DT-5TXR/DT-5TS panel meter safely and with excellent results.

If you have any questions regarding our product(s), call your local Shimpo representative or contact Shimpo directly for assistance.

## Contents

Standard Accessories .....	3
Features and Benefits .....	3
Important Safety Precautions .....	3
Display and Keypad .....	4
Rear Panel and Terminals .....	5
Set-Up .....	5
Power .....	5
Sensor Connection .....	5
Self-Test .....	5
Panel Installation .....	6
Factory Settings .....	6
Parameter Settings .....	6
Function Settings .....	6
Operation .....	7
Mode Operation Selection .....	7
Setting Mode Parameters .....	7
Mode -01- (RPM or Rate Measurement) .....	7
Mode -02- (Elapsed Time Measurement/Monitoring) .....	9
Mode -03- (Process Time Measurement) .....	10
"How to Operate" Teaching Feature .....	10
Setting High and Low Limits .....	11
Setting Functions .....	11
Memory Feature .....	12
Setting Examples .....	13
Modules Available for DT-5TXR .....	15
DT-5TXR with DOP-CPTR Module .....	15
DOP-TRTR Module .....	16
DOP-FVTR or DOP-FVC Module .....	16
DOP-BCD Module .....	18
Dimensions and Specifications .....	19
Troubleshooting .....	20
Warranty .....	20

## Standard Accessories

If any damage is apparent, do not unpack the panel meter. Notify the shipping carrier immediately for damage claim instructions. Refer to the label to confirm model number ordered and record serial number for future reference.

Items included with the DT-5TXR or DT-5TS are:

- *Mounting adapter, 2 pieces (attached)*
- *Mounting screw, 2 pieces (attached)*
- *Decal sheet*
- *Front button protective cover (attached)*

## Features and Benefits

The DT-5TXR/DT-5TS panel meter offers many features and benefits including:

- Accepts a wide range of ppr (1-9,999) to accommodate any sensor commonly found in the field
- Wide range of AC voltage input (85 – 264 VAC 50/60 Hz) eliminates duplicity of models or changing of transformers
- Scalable; able to measure in various units
- Standard 1/8 DIN mounting enables easy mounting while saving time
- Accepts modules (DT-5TXR only) which provide different types of outputs, i.e. analog voltage, analog current (4-20 mA), relay closures (set points), BCD output and others for recording purposes or data analysis

## Important Safety Precautions



Confirm that the unit is turned OFF when connecting or disconnecting the unit to a sensor.



Never use wet hands when connecting or disconnecting a sensor or checking the unit.



Always use the correct voltage (AC type: 85-264VAC, DC type: 9-35VDC).



Do not position the signal wires and power cord near each other.



Remember to check terminal connections, as they may become loose due to vibration.



Do not use or store unit in extreme temperatures; normal operating temperature is 32-113°F (0-45°C).



Do not use or store unit in oily, dusty, or high humidity areas.



Do not use chemicals to clean the case; use a damp, soapy cloth.



Do not operate the unit in a location where electrical noise, static electricity or excessive vibration is present.

# DT-5TXR/DT-5TS

## Display and Keypad

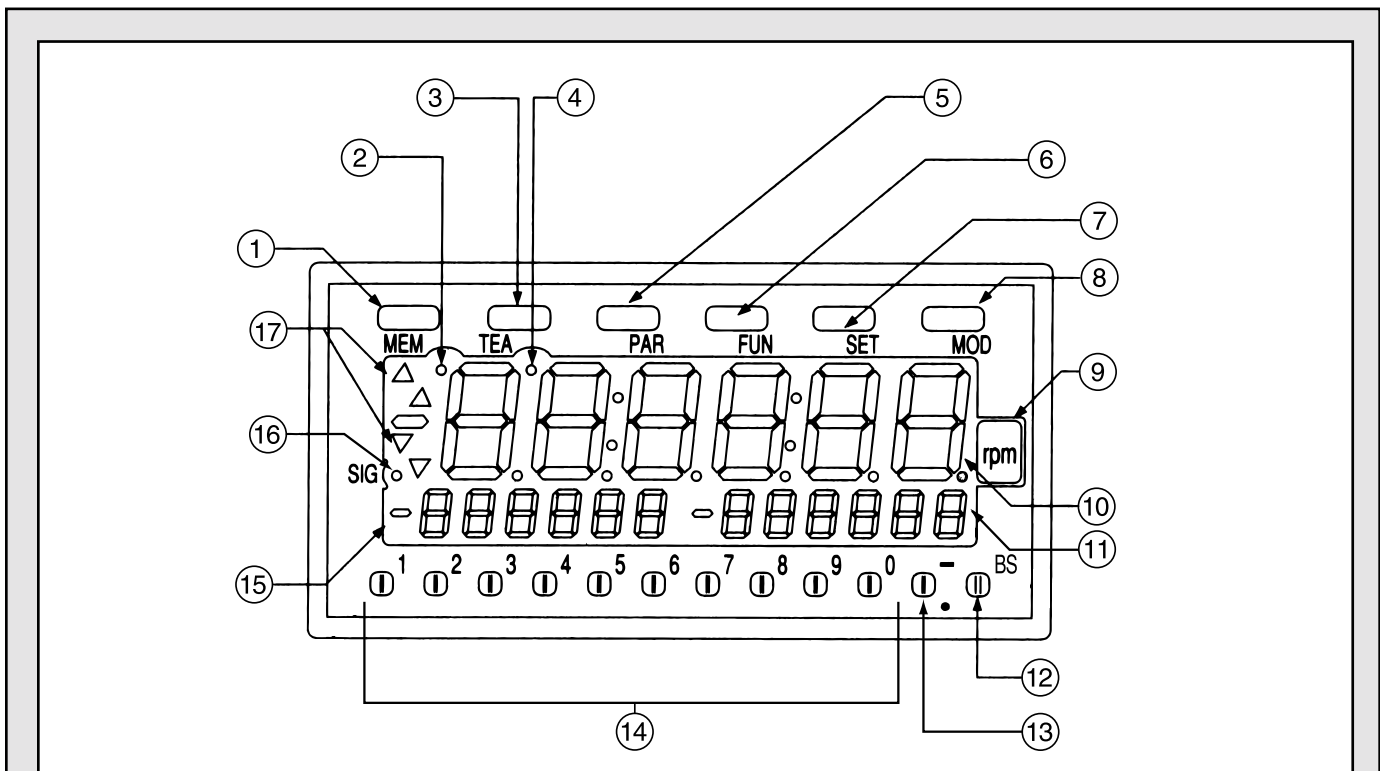

NO.	DESIGNATION	FUNCTION
1.	Memory Button	Activates memory function
2.	Memory Indicator	ON when memory function is activated
3.	Teaching Button	Quick scaling setup mode
4.	Teaching Indicator	ON when in quick scaling setup mode
5.	Parameter Button	For parameter setup
6.	Function Button	For function setup
7.	Set Button	Sets parameter's functions
8.	Mode Button	Mode selection
9.	Unit Decal	Area for decal
10.	Primary Display	Displays units of measurement
11.	Secondary Display B	Secondary display
12.	Backspace Button	Backspace for corrections
13.	Negative Sign/Decimal Point Button	Negative sign setting/decimal point shift
14.	Numeric Button	For various functions
15.	Secondary Display A	Secondary display
16.	Signal Indicator	Blinking when signal is present
17.	Comparator Indicator	Indicates comparator condition

## Rear Panel and Terminals

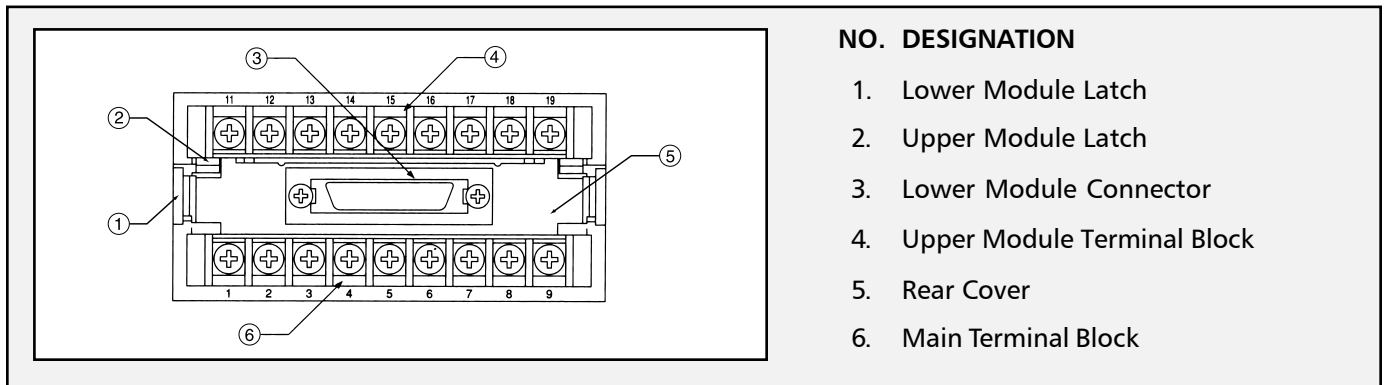

## Set-Up

### Power

Refer to diagram 1 (right) for location of the terminals.

### AC Models

Apply 85 – 264 VAC, 50/60 Hz between terminals 1 and 2.

### DC Models

Apply 9 – 35 VDC between terminals 1 (positive) and 2 (negative) on the main terminal block.

After proper power (AC or DC) is applied to the unit and before any sensor is connected, the LED display will light up.

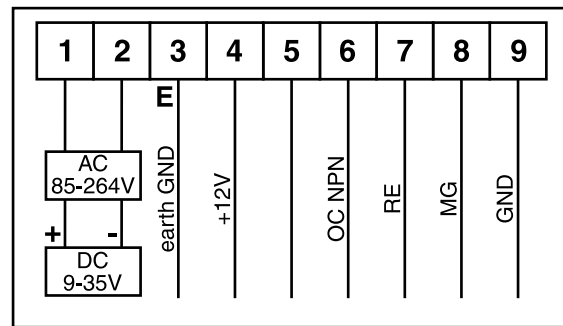

diagram 1

## Sensor Connection

Use the chart below to determine how to connect the DT-5TXR/DT-5TS to Shimpo sensors:

SENSOR	TYPE	TERMINAL NUMBER	FREQUENCY or RPM RANGE	OPERATION TEMPERATURE	FILTER
RE1B-60C	Rotary Pulse Generator	4,7,9	0 – 5,000 RPM	14° - 122°F (-10° - +50°C)	30 kHz
RE1B-600C			0 – 3,000 RPM		
RE1B-1000C			0 – 1,800 RPM		
MCS-625	Retro-Reflective	4,6,9	0 – 250 Hz	-22° - +120°F (-30° - +48.9°C)	100 kHz
MCS-655			0 – 333 Hz	-13°F - +131°F (-25° - +55°C)	100 kHz
MP-10	Magnetic	3,8,9		-40° - +221°F (-40° - +105°C)	10 kHz
3030AN				-100° - +225°F (-73° - +107°C)	
3070A*				-100° - +200°F (-73° - +104°C)	
Contact Closure	Relay or Solenoid	Jumper 5 and 6 Connect 6,9	< 20 Hz		20 Hz
BI2-S12	Open Collector NPN Proximity	4,6,9	0 – 2 kHz	-13° - +158°F (-25° - +70°C)	100 kHz
SE-G	3-wire Switching Proximity	4,7,9	0 – 8 kHz	-4°F - +158°F (-20°C - +70°C)	30 kHz
DJ2-G	2-wire Non Switching Proximity	4,8	0 – 1 kHz	-68° - +140°F (-55° - +60°C)	10 kHz

\* For hazardous locations

## Self-Test

To confirm that all display LEDs are operating correctly, a self-test is recommended (see "Display and Keypad" section for button locations):

1. Press and hold the MODE button for approximately 3 seconds; "0" will begin flashing until "-01-" appears on the display.
2. Press any of the lower buttons (NUMERIC, NEGATIVE SIGN/DECIMAL POINT, BACKSPACE) to scroll through "-02-", "-03-" and "-04-" until "-99-" appears on the display.
3. Press the SET button to begin the self-test. The entire display will cycle through all digits, arrows, dashes, colons, decimal points, etc.
4. When satisfied that all LED's are operational, press the SET button to exit.

# DT-5TXR/DT-5TS

## Panel Installation

Install the DT-5TXR/DT-5TS on panel as follows:

1. Confirm that the panel thickness is 0.047" - 0.197" (1.2 mm - 5 mm).
2. Remove the two mounting adapters (provided) from the DT-5TXR/DT-5TS (diagram 2).
3. Install a water-resistant gasket on the panel (see diagram 3 & 4).
4. Hold the panel meter in a horizontal position, insert it into the cut-out and press against gasket (diagram 5).
5. Replace the two mounting adapters (diagram 6).
6. The DT-5TXR/DT-5TS is secured on the panel by using the two mounting screws (provided) (see diagram 7).

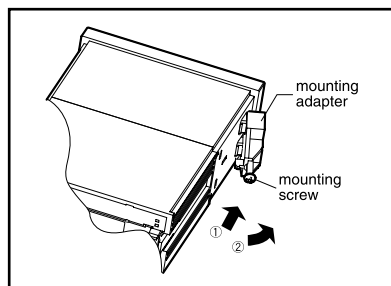

diagram 2

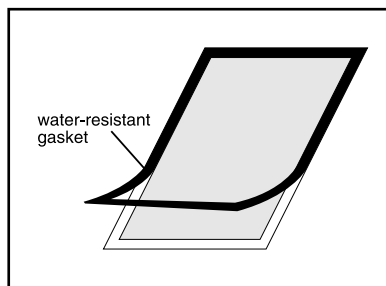

diagram 3

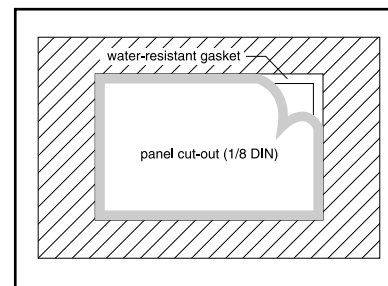

diagram 4

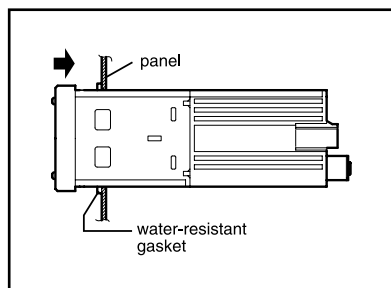

diagram 5

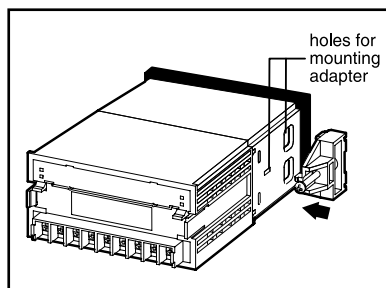

diagram 6

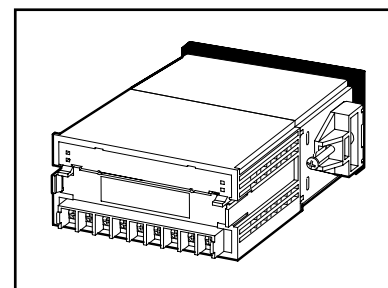

diagram 7

## Factory Settings

The following charts reflect the default parameter and function settings as programmed by the factory:

### Operating Mode -01- (RPM or Rate Measurement)

PARAMETER	DESCRIPTION	DEFAULT FACTORY SETTING	
		DISPLAY	MEANING
1	Pulses per revolution	0001	1 ppr
2	Sensing RPM	01000	1,000 RPM
3	Display units	1000	1,000
4	Update time	1.0	1 second
5	Display "Hold" after input signal ceases	006.0	6 seconds
6	Input filter	10	10 kHz

FUNCTION	DESCRIPTION	DEFAULT FACTORY SETTING	
		DISPLAY	MEANING
1	The 2nd HI and 2nd LO limit setting	0 0 0 0 0 0	0
2	Hysteresis of 1st HI and 1st LO set	0 0	0
3	Secures the 1st HI and 1st LO set	0	Not secured
4	Output activation of any set limit	0 0	0 seconds
5	Selection of secondary display	0	1st HI and 1st LO limit set
6	Main display shows 0 below this no. setting	0 0 0 0 0 0	0
7	Averages the sensor output frequency	0	None
8	Deceleration to ZERO display value	0	Off

### Output modules (DT-5TXR only)

10	Logic of BCD output	0	Negative true logic
11	Analog output value	0 0 1 0 0 0	1000
12	Minimum value of analog output	0 0 0 0 1 0	10
13	Update time for analog output	0	About 10 msec
14	Offset for analog output	0 0 0 0	0%

## Operation

### Mode Operation Selection

Depending upon the type of application, the DT-5TXR/DT-5TS offers different modes of operation; these modes and their functions are:

MODE	FUNCTION
-01-	RPM or rate measurements
-02-	Elapsed time measuring / monitoring
-03-	Process time measurement
-04-	Flow rate measurement (used only in Japanese market)
-99-	Self-test (see "Self-Test" section under "Set-Up")

Select the mode of operation as follows:

1. Press and hold the MODE button for approximately 3 seconds; "0" will begin flashing until one of the five modes (see table above) appears on the display.
2. Each time one of the lower buttons (NUMERIC, NEGATIVE SIGN/DECIMAL POINT, BACKSPACE) is pressed, the display will scroll through these modes as indicated below:

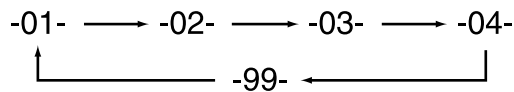

3. Press the SET button to store the mode of operation and exit.

### Setting Mode Parameters

Modes -01-, -02- and -03- have several parameters that must be selected and programmed into the DT-5TXR/DT-5TS. In addition, there are also function settings to further customize the DT-5TXR/DT-5TS.

**NOTE:** Because the flow rate measurement mode (-04-) is only used in the Japanese market, it is not covered in this manual. Contact Shimpo for additional information if necessary.

**NOTE:** If a mistake is made entering any number, simply press the BACKSPACE button to erase the last digit on the primary display.

### Mode -01- (RPM or Rate Measurement)

The following parameters must be set in mode -01- so that the DT-5TXR/DT-5TS will display the correct readings:

PARAMETER	DESCRIPTION	RANGE	FACTORY SETTING	
			DISPLAY	MEANING
1	Pulses per revolution	1 - 9999	0001	1 ppr
2	Sensing RPM	Up to 99999	01000	1000 RPM
3	Display units	0.00001 - 999999	1000	1000
4	Update time	0.2, 0.5, 1.0, 2.0, 5.0, 10, 15, 30, 60 seconds	1.0	1 second
5	Display "Hold" after input signal ceases	0.1 - 150 seconds	006.0	6 seconds
6	Input filter	10, 30, 100, 0.02 kHz	10	10 kHz

# DT-5TXR/DT-5TS

## Mode -01- (RPM or Rate Measurement) continued

Set the parameters in mode -01- as follows:

1. Press the PAR button; the display will indicate:



The "-01- P01" on secondary display A indicates that the meter is in the RPM mode (-01-) and parameter 1 is showing on the primary display (1 ppr [factory setting]).

2. Using the NUMERIC buttons, enter the number of pulses per revolution produced by the sensor being used (1-9999). For example, if a rotary pulse generator has an output of 60 ppr, then 6 0 would have to be entered.
3. Press the PAR button; the display will reflect:

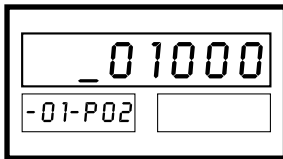

The secondary display A reflects that the meter is still in mode -01-, but parameter 2 is showing on the primary display (1000 RPM [factory setting]).

4. Using the NUMERIC buttons, enter the number of RPM that must be monitored (up to 99999). For example, if the motor to be monitored has a speed of 1,750 RPM, then 1 7 5 0 would have to be entered.
5. Press the PAR button; the display will show:

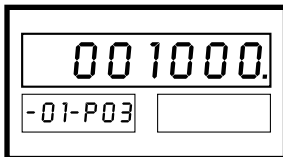

As the secondary display indicates, parameter 3 is reflected on the primary display (1000 [factory setting]).

6. Use the NUMERIC buttons to enter the value of the display as it relates to the already programmed RPM setting. For example: if the desired display reading is feet per minute and the belt that is being measured is moving at a rate of 55.5 f/min, then 5 5 5 would have to be entered and the negative/decimal point button pressed once. If the desired reading is RPM, then the same 1 7 5 0 would have to be entered.

7. Press the PAR button; the display will reflect:

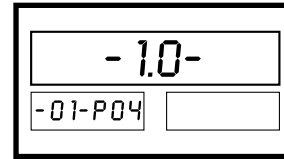

Parameter 4 is now showing on the primary display (1.0 second [factory setting]).

8. Use any of the lower buttons to scroll through the update times (see table under "Setting Mode Parameters" on page 7) until the desired reading is displayed.

9. Press the PAR button, the display will indicate:

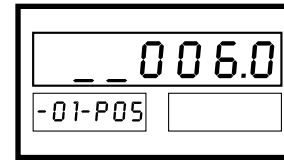

The primary display is now reflecting parameter 5 (6 sec [factory setting]).

10. Press the NUMERIC buttons to enter the value in seconds that the display should hold the final reading after the input signal ceases.

11. Press the PAR button; the display will reflect:

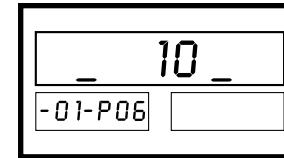

Parameter 6 is showing on the primary display (10 kHz [factory setting]).

12. Refer to the "Connection of Sensors" chart under the "Set-Up" section for the proper filter for the sensor being used. Press any of the lower buttons to scroll through the input filters (see table under "Setting Mode Parameters" on page 7) until the desired reading is showing.

13. Press the SET button to store the parameter settings and exit.

**NOTE:** Please see page 13 for an example of MODE -01- operation.



## Mode -02- (Elapsed Time Measurement/Monitoring)

The following parameters must be set in mode -02- so that the DT-5TXR/DT-5TS will display the correct readings:

PARAMETER	DESCRIPTION	RANGE	FACTORY SETTING	
			DISPLAY	MEANING
1	Pulses per revolution	1 – 9999	0001	1 p/r
2	Sensing RPM	Up to 99999	01000	1000 RPM
3	Display units	a)Hours, Minutes, Seconds 0 : 00 : 00 – 9 :59 : 59	_ 010 : 00	10.0 seconds
		b)Seconds 0 : 00 – 999 : 99		
4	Update time	0.2, 0.5, 1.0, 2.0, 5.0, 10, 15, 30, 60 seconds	_ 1.0 _	1 second
5	Display "Hold" after input signal ceases	0.1 – 150 seconds	006.0	6.0 seconds
6	Input filter	10, 30, 100, 0.02 KHz	10	10 kHz

Except for parameter 3, the instructions are the same for setting the parameters as in mode -01-.

Instructions for setting the parameters in mode -02- are as follows:

1. Press the PAR button.
2. Use the NUMERIC buttons to enter the number of pulses per revolution.
3. Press the PAR button.
4. Press the NUMERIC buttons to enter the sensing RPM.
5. Press the PAR button; the display will reflect:

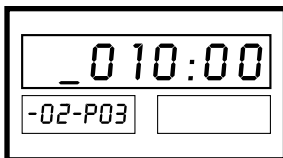

The secondary display A reflects that the meter is in mode -02-, but parameter 3 is showing on the primary display (10 sec [factory setting]).

6. Use the NUMERIC buttons to enter the number of seconds to the hundredth place (000.00). If time in hours, minutes, and seconds is necessary, press the NEGATIVE/DECIMAL POINT button, then use the NUMERIC buttons to enter the amount of time as it relates to the already programmed RPM setting.
7. Press the PAR button.
8. Use any of the lower buttons to scroll through (see table above) and select an update time.
9. Press the PAR button.
10. Use the NUMERIC buttons to enter the time in seconds that the display should hold in the final reading.
11. Press the PAR button.
12. Refer to the "Sensor Connection" table under the "Set-Up" section for the proper filter for the sensor being used. Press any of the lower buttons to scroll through the input filters (see table above) until the desired reading is showing.
13. Press the SET button to store the parameters and exit.

**NOTE:** Please see page 13 for an example of MODE -02-.

# DT-5TXR/DT-5TS

## Mode -03- (Process Time Measurement)

The following parameters must be set in mode -03- so that the DT-5TXR/DT-5TS will display the correct readings:

PARAMETER	SETTING	RANGE	FACTORY SETTING	
			DISPLAY	MEANING
1	Hours, minutes, seconds or Hundreds of a second	00:00:00 or 0:00	0:00	1/100 second
2	Input signal edge	0 = Trailing edge 1 = Leading edge	_ 1 _	Leading edge
3	Auto zero time	0.1 – 3,600 seconds	3600.0	3600 seconds
4	Filter	10, 0.02 kHz	10	10 kHz

The parameters for mode -03- are completely different for those of mode -01- and mode -02-.

Instructions for setting parameters in mode -03- are as follows:

1. Press the PAR button; the display will indicate:

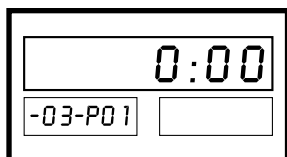

The secondary display A shows that the meter is in mode -03-, and parameter 1 is showing that the primary display will count in hundredths of a second (000.00).

2. Use any of the lower buttons to toggle between the meter reading in seconds or reading in hours, minutes, and seconds (see table above).
3. Press the PAR button; the display will indicate:

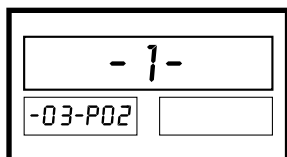

Parameter 2 is showing on the primary display (1 [factory setting]).

4. The input signal edge can be triggered by the leading edge (1) or trailing edge (0). Press any of the lower buttons to toggle between these two settings (see table above).
5. Press the PAR button; the display will reflect:

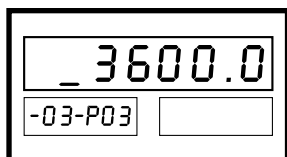

The primary display is now showing parameter 3 (3600 sec [factory setting]).

6. Use the NUMERIC buttons to enter the amount of time in seconds that the display needs to hold the measured process.

7. Press the PAR button; the display will indicate:

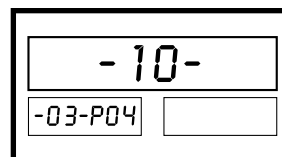

Parameter 4 is showing on the primary display (10kHz [factory setting]).

8. Refer to the "Connection of Sensors" chart under the "Set-Up" section for the proper filter for the sensor being used. Press any of the lower buttons to scroll through the input filters (see table above) until the desired reading is showing.
9. Press the SET key to save these parameter settings and exit.

**NOTE:** Please see page 14 for an example of MODE -03-.

## "How to Operate" Teaching Feature

**NOTE:** This feature can only be used in mode -01-.

With the DT-5TXR/DT-5TS it is possible to monitor the speed of a motor when the number of pulses that the sensor is generating is unknown. The RPM can be programmed into the meter if it is already known or discovered by using a handheld tachometer (Shimpo models DT-105A or DT-107A for contact measurement; DT-205LR or DT-207LR for non-contact measurement). The meter will then use this number to set parameters 1 and 2.

Set the teaching feature as follows:

1. Determine the output RPM.
2. Confirm that the meter is receiving a signal from the sensor (the SIG indicator will be illuminated).
3. Press the TEA button (the TEA indicator will be illuminated).
4. Use the NUMERIC buttons to enter the known RPM.
5. Press the SET button to save the setting.

## Setting High and Low Limits

If the variation of motor speed or time measurement is important and a “range” must be monitored, then “high” and “low” visual limits can be programmed through secondary displays A and B, respectively.

Instructions to set the high and low limits:

1. Use the lower buttons (1-6) to set the high limit on secondary display A. There are six digits that can be programmed and each one of these buttons corresponds with the digit position. Each time one of the buttons is pressed, the display will increment that position one number (for example, if 56000 RPM needs to be programmed as the high limit, then NUMERIC button 2 would have to be pressed five times and NUMERIC button 3 would be pressed six times).
2. Use the lower buttons (7 - BACKSPACE) to set the low limit on secondary display B. These six buttons also correspond with the digit positions and will increment that position one number (for example, if 3425 RPM needs to be programmed as the low limit, then NUMERIC button 9 should be pressed three times, NUMERIC button 0 pressed four times, NEGATIVE/DECIMAL button pressed twice and the BACKSPACE button pressed five times).
3. Press the SET button to store the limit settings.

The comparator indicators will illuminate when the primary display exceeds the high set point ( Δ ) or the low set point ( ∇ ).

**NOTE:** The DT-5TXR provides relay or transistor closures (see section “Modules Available for DT-5TXR” on page 15).

## Setting Functions

The DT-5TXR/DT-5TS has a variety of functions that can be programmed to further customize the meter. Listed below are the available functions:

### MODE -01-

FUNCTION	DESCRIPTION	RANGE	FACTORY SETTING	
			DISPLAY	MEANING
1	The 2nd high and the 2nd low limit setting	000000 - 999999	0 0 0 0 0 0	0
2	Hysteresis of 1st high and 1st low setting	0 - 99	___ 0 0	0
3	Secures the 1st high and 1st low setting	0 (not secured )/1 (secured)	0	Notsecured
4	Output activation of any set limit	0 - 99 second	___ 0 0	0 second
5	Selection of secondary display	0 (1st high and 1st low limit set) 1(blank)/2 (real RPM)	0	1st high and 1st low limit set
6	Main display shows 0 below this no. setting	000000 - 999999	0 0 0 0 0 0	0
7	Averages the sensor output frequency	0 (none)/1 (three times)/2 (ten times)	_ 0 _	None
8	Deceleration to ZERO display value	0 (of)/1 (on )	0	Off

### MODE -02-

FUNCTION	DESCRIPTION	RANGE	FACTORY SETTING	
			DISPLAY	MEANING
1	The 2nd high and the 2nd low limit setting	0:00:00 - 9:59:59 or 0:00 - 999.99	_ 0 0 0 0 0	1/100 second
2	Hysteresis of 1st high and 1st low set	0 - 99	___ 0 0	0
3	Secures the 1st high and 1st low set	0 (Not secured )/1 (Secured)	0	Notsecured
4	Output activation of any set limit	0 - 99 second	___ 0 0	0 second
5	Selection of secondary display	0 (1st high and 1st low limit set)/1 (blank)/2 (real RPM)	0	1st high and 1st low limit set
6	Main display shows 0 below this no. setting	000000 - 999999	0 0 0 0 0 0	0
7	Averages the sensor output frequency	0 (none)/1 (three times)/2 (ten times)	_ 0 _	None
8	Deceleration to ZERO display value	0 (of)/1 (on )	0	Off

### MODE -03-

FUNCTION	DESCRIPTION	RANGE	FACTORY SETTING	
			DISPLAY	MEANING
1	The 2nd high and the 2nd low limit setting	0:00:00 - 9:59:59 or 0:00 - 999.99	0 0 0 0 0	1/100 second
2	Hysteresis of 1st high and 1st low setting	0 - 99	0 0	0
3	Secure the 1st high and 1st low setting	0 (not secured )/1 (secured)	_ 0 _	Notsecured
4	Output activation of any set limit	0 - 99 second	0 0	0 second
5	Selection of secondary display	0 (1st high and 1st low limit set)/1 (blank)/2 (real RPM)	0	1st high and 1st low limit setting

**NOTE:** Although the functions are rarely used in mode -03-, they are still available.

## Setting Functions (continued)

Instructions to set functions are as follows:

1. Press the FUN button; the display will indicate:

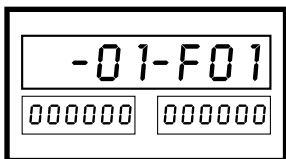

**NOTE:** The display will always show what operating mode is set (mode -01- in this example) and what function (1) is being displayed.

2. Use the lower keys to set secondary high and low limits (follow the same instructions listed under "Setting High and Low Limits" section on page 7).
3. Press the FUN button; the display will reflect:

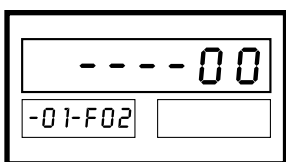

Function 2 is now showing on the primary display (factory setting).

4. Use the NUMERIC buttons to set the hysteresis of the upper and lower limits.
5. Press the FUN button; the display will show:

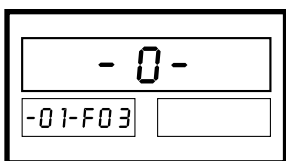

Function 3 is being reflected on the primary display (factory setting).

6. Use any of the lower buttons to toggle between securing and not securing (see tables on page 11) the primary high and low settings.
7. Press the FUN button; the display will reflect:

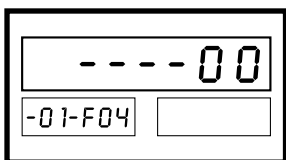

Function 4 is now showing (factory setting).

**NOTE:** This function is mainly used with mode -01- only.

8. Use the NUMERIC buttons to set the output activation of any set limit.
9. Press the FUN button, the display will show:

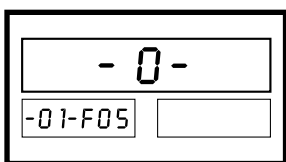

Function 5 is now showing (factory setting).

10. Use any of the lower buttons to toggle between the three settings (see tables on page 11) for what the secondary displays (A and B) will show.
11. Press the FUN button; the display will reflect:

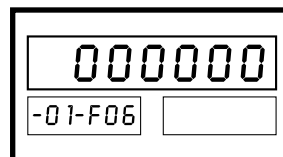

Function 6 is now showing (factory setting).

12. Use the NUMERIC buttons to enter the number at which the primary display should read zero.  
For example: if it is desired for the display to read zero when the RPM drops below 600, then 6 0 0 should be entered.
13. Press the FUN button; the display will show:

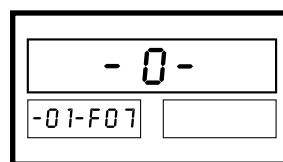

Parameter 7 is now showing (factory setting).

14. Use any of the lower buttons to scroll between the three types of averaging (see tables on page 11) for an unstable sensor. The number of times that the meter will average the frequency is directly related to the update time chosen (parameter 4).
15. Press the FUN button; the display will reflect:

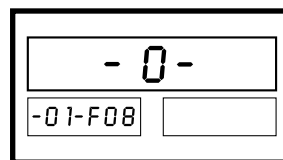

Parameter 8 is now showing (factory setting).

16. Use the lower keys to toggle between either having the deceleration to zero value "on" or "off" (see tables on page 11).
17. Press the SET button to store the function settings and exit.

## Memory Feature

The function of the MEM button is to aid the DT-5TXR/DT-5TS to memorize and display through the secondary displays the maximum and minimum value of the main display for as long as it has been activated. Simply activate the MEM button by pushing it momentarily. The lower left secondary display will reflect the maximum value of the main display and the lower right secondary display will reflect the minimum value of the main display. Also a small LED will begin to flash.

To de-activate the memory feature, simply push the MEM button again. The LED under it will stop flashing and the secondary displays will return to their previous state.

## Setting Examples

### MODE -01- (RPM or Rate Measurement)

The DT-5TXR/5TS units are fully scalable, which means that RPM can be used to display linear speed in many units, i.e. ft/m, yd/m, m/m, in/m etc. Please use the following example as a guide for programming this feature.

Suppose a motor drives a roller through a speed reducer and the speed of the roller is 100 RPM when the speed of the motor is 1,700 RPM (due to load, in this case the roller). The roller feeds a belt that carries material from point A to point B and we want to monitor the speed of the belt in ft/m at all times.

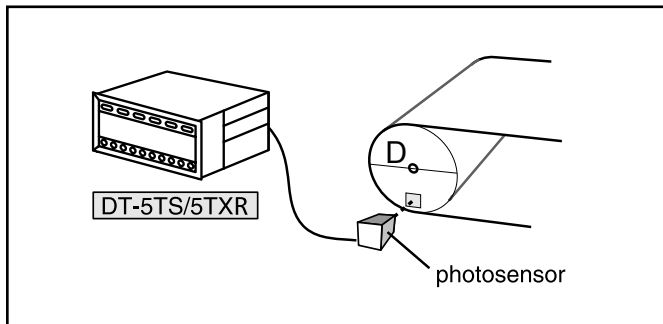

The following are known: (refer to the mode -01- parameters table on the bottom of page 7)

- Parameter 1 = 1 p/r (one marker on the face of the roller)
- Parameter 2 = 100 RPM (due to speed reducer)
- Parameter 3 = ? (ft/m)

Parameter 3 is calculated by determining the circumference of the roller and multiplying by the RPM (parameter 2). The circumference can be determined by multiplying  $\pi$  times the diameter ( $C=\pi D$ ). The diameter must be measured in whatever unit needs to be monitored. Because ft/m needs to be monitored, the diameter needs to be measured in feet. If it is assumed that the roller is one foot in diameter ( $D=1$ ) and  $\pi=3.14159$ , then the circumference would have to be 3.14159 ft. This number would then be multiplied by 100 (parameter 2) to arrive at 314.159 ft/m, parameter 3.

Now:

- Parameter 1 = 1 p/r
- Parameter 2 = 100 RPM
- Parameter 3 = 314.159 ft/m

After these parameters have been programmed (see page 8), feet per minute will be displayed and will fluctuate with the changing RPM.

For example: if the RPM drops to 50, then the display will show 157.079 ft/m.

In the example given, parameters 4, 5 and 6 needed no change; these are adjusted according to operator preference.

Parameter 4 is selectable and is used when there is a steady increase/decrease in speed and the operator wants to observe the changes (in this case higher update times are selected) or if the speed changes rapidly within certain limits (this may bother the observer) a lower update time is selected.

Parameter 5 is set according to how quickly the operator wants to see the display go to "0" after the sensor stops producing an output.

Set parameter 6 according to the sensor being used.

### MODE -02-

As stated in the previous example, the DT-5TXR/DT-5TS units are fully scalable. This is true for not only rate measurement but also time measurement. The following is an elapsed time measurement/monitoring example.

The elapsed time for curing a product in a commercial oven is critical and must be monitored. From the oven's specifications it is possible to discover either the velocity (speed) that the conveyor moves product or the amount of time that the product has to be in the oven.

**NOTE:** If neither of these can be found, simply use a hand held tachometer to measure the conveyor belt speed.

From either one of the above methods the 5m-long oven is determined to have a belt speed of 2.8m/m. In this example a rotary pulse generator is being used that is moving at 1,200 RPM and generating 60 pulses per revolution. Therefore the following facts are known:

- The length of the oven is 5 meters
- The speed of the pulse generator is 1,200 RPM (parameter 2)
- The p/r of the pulse generator is 60 pulses (parameter 1)
- The belt speed is 2.8 m/m

Use the formula  $t=d/v$ , to determine the amount of time that the product will spend in the oven (parameter 3). Dividing 5 (length of oven) by 2.8 (speed of oven conveyor) equals 1.786 min (107 seconds or 1 min and 47 seconds), parameter 3 (see page 9 for programming). Parameters 4 and 5 should be set to the operator's preference. Set parameter 6 according to the sensor being used.

Now the unit will display time as it relates to the RPM.

For example, if the RPM falls to 600, the display will show 214 seconds.

# DT-5TXR/DT-5TS

## Setting Examples (continued)

### MODE -03-

This mode is used to measure the time a process takes from start to finish. An example could be a CNC machine that is programmed to make a certain part (push, bend, drill and stop). Need to know how much time it takes from start to finish so that future plans can be made when time comes to make several pieces of the same part. This requires a timer to be able to start counting then stop and display the actual process time.

The DT-5TXR/DT-5TS has a MODE for this application (and similar ones) where it can measure the ON time of a signal that starts when the process begins until it ends (see signal waveform diagram - top, right).

**NOTE:** The diagrams to the right show a typical process application where the proximity switch sends a signal to the DT-5TXR/DT-5TS telling it when the process started and also when it is finished upon the return of the press table. As was mentioned above, MODE -03- of the DT-5TXR/5TS is able to count and display that process time.

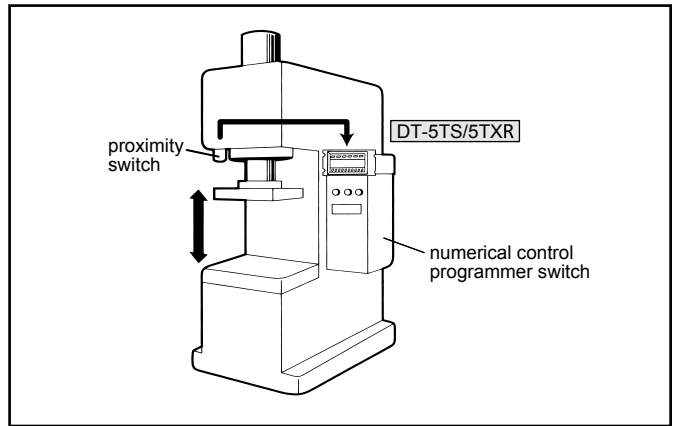
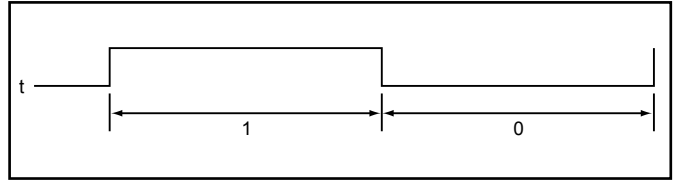

## Modules Available for DT-5TXR

A variety of modules are available to provide an array of output and input options when using the DT-5TXR.

Most of the modules have either a "T" or "C" suffix in the part number. The "T" indicates that the module's communication is wired through the terminal; the "C" indicates that the module's communication is wired through a 36 pin connector (see "Rear Panel and Terminals", top of page 5). The only exception is the DOP-BCD module, which is always wired through the 36-pin connector.

When purchasing a DT-5TXR with modules, please consult the following:

### Upper Connector Options (with Terminal Block "T")

DOP-FVTR (Analog output: 0-1VDC, 1-5VDC, 0-10VDC and 4-20mA)

DOP-CPTR (Relay output: HI, GO, LO; 3 "C" type relays)

DOP-TRTR (NPN OC output: H (1), H (2), GO, L (1), L (2) and ZERO)

DOP-RMTR (Ratio of two input functions)

### Lower Connector Options (with Connectors "C")

DOP-FVC (Analog output: 0-1VDC, 1-5VDC, 0-10VDC and 4-20mA)

DOP-BCD (BCD output, TTL compatible)

### All Module Combinations/Arrangements

The above modules are available for the DT-5TXR with the following combinations:

DT-5TXR	DT-5TXR-RMTR
DT-5TXR-FVTR	DT-5TXR-RMTR-FVC
DT-5TXR-FVTR-BCD	DT-5TXR-RMTR-BCD
DT-5TXR-CPTR	DT-5TXR-FVC
DT-5TXR-CPTR-FVC	DT-5TXR-BCD
DT-5TXR-CPTR-BCD	
DT-5TXR-TRTR	
DT-5TXR-TRTR-FVC	
DT-5TXR-TRTR-BCD	

Using any of these part numbers ensures that the unit will arrive assembled. Please consult the installation manual (provided with individual modules) if removal/replacement of the modules is required.

## DT-5TXR with DOP-CPTR Module

### DT-5TXR-CPTR

The model DT-5TXR-CPTR provides three "C" type relays that can be used for setting two "set points", one high and one low. The third relay provides a GO signal and can be used as such if needed.

Connect proper voltage (according to AC or DC model configuration) between terminals 1 and 2 on the DT-5TXR terminal block. Select high and low limits as described in the "Setting High and Low Limits" section. If it is assumed that the normal (GO) range is X, then the high and low set points (limits) will react as follows:

Low set point  $\leq \dots X \leq \dots$  high set point

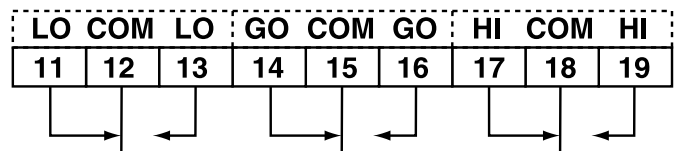

Relay contact ratings:

250VAC (5A)	} Resistive loads
30VDC (5A)	
250VAC (2.5A)	} Inductive loads
30VDC (2.5A)	

**NOTE:** Relay contacts under above conditions have a life of approximately 100,000 operations.

# DT-5TXR/DT-5TS

## DT-5TXR with DOP-TRTR Module

### DT-5TXR-TRTR

The DT-5TXR panel meter with the DOP-TRTR module provides two high set points (limits) and two low set points in addition to the normal GO signal output. The module has an additional ZERO speed signal output feature which is very useful in many applications.

Connect proper voltage (AC or DC depending on model) between pin 1 and 2 and set your mode, parameters etc. as described in previous pages and follow the instructions described on page 11 to set up the two sets of low and high set points (limits).

When using the DOP-TRTR module, the various outputs will appear on the terminal strip as shown below:

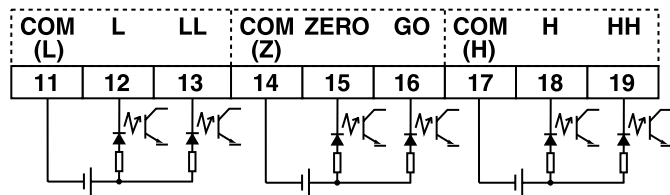

All outputs should be isolated through an opto-coupler. Each transistor can handle up to 30VDC and no more than 20mA.

## DT-5TXR with DOP-FVTR or DOP-FVC Module

### DT-5TXR-FVTR/DT-5TXR-FVC

The DOP-FVTR or DOP-FVC module coupled with the DT-5TXR panel meter provides three popular voltage outputs and one current output for recording purposes and PLC applications. The voltages are:

- 0 to 10 VDC
- 1 to 5 VDC
- 0 to 1 VDC
- The current is 4 - 20mA

**NOTE:** Only one output can be used at a time.

MODEL	DOP-FVT/DOP-FVC	
Output	Current Output	4 – 20 mADC
	Voltage Output	0 – 10 VDC
		1 – 5 VDC
		0 – 1 VDC
Load	Current Output	Less than 500Ω
	Voltage Output	1 kΩ or higher

The different outputs are not achieved through programming, but by making the proper connections.

The connections for the DOP-FVTR module are as follows:

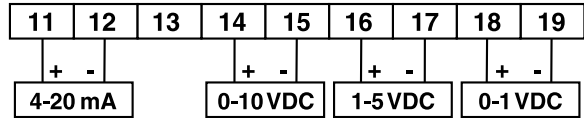

Connections for the DOP-FVC module are as follows:

DESIGNATION	PIN No.		DESIGNATION
4-20 mA Plus	1	19	4-20 mA Minus
	2	20	
NC	3	21	NC
	4	22	
	5	23	
	6	24	
	7	25	
	8	26	
0-10 VDC	9	27	GND
	10	28	
NC	11	29	NC
	12	30	
1-5 VDC	13	31	GND
	14	32	
NC	15	33	NC
	16	34	
0-1 VDC	17	35	GND
	18	36	

The voltage output will be linear and directly correspond with programmed maximum and minimum RPM values.



## DT-5TXR-FVTR/DT-5TXR-FVC (continued)

Instructions to set the analog output characteristics are as follows:

1. Press the FUN button eleven times; the display will reflect:

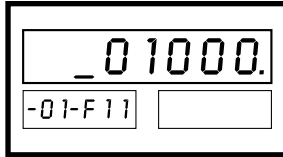

The display shows that the maximum RPM is set for 1,000 (factory setting).

2. Using the NUMERIC buttons, enter the maximum number of RPM to be monitored.

For example: if using the 0 to 10VDC output and the maximum RPM to be monitored is 1,500, then 1 5 0 0 would have to be entered; this will provide a 10VDC output at 1,500 RPM.

3. Press the FUN button; the display will show:

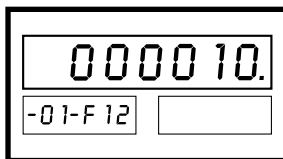

Displayed is the minimum RPM (factory setting).

4. Using the numeric buttons, enter the minimum number of RPM to be monitored.

For example: if using the 0 to 10VDC output and the minimum RPM to be monitored is 1,000, then 1 0 0 0 would have to be entered; this will provide a 0VDC output at 1,000 RPM.

5. Press the FUN button again; the display indicates:

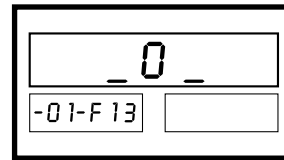

The display reflects the factory setting.

6. Use any of the lower buttons to toggle between the two settings for the update time for the analog output. "0" means that the update time will be approximately 10 msec, "1" indicates that the update time will correspond with the display update time already chosen (see "Setting Mode Parameters" #4).
7. Press the FUN button; display will reflect:

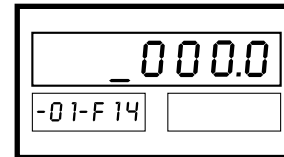

The display shows the factory setting.

8. Use the lower buttons to program the desired offset percentage setting for the analog output. This number can be from -100% to 100%.
9. Press the SET button to store the analog output characteristics and exit.

# DT-5TXR/DT-5TS

## DT-5TXR with DOP-BCD Module

### DT-5TXR-BCD

The model DT-5TXR-BCD combination satisfies PCs and PLCs that require a BCD (parallel) signal. The DOP-BCD module can be configured with a negative logic output (0=HI and 1=LO) or a positive logic output (0=LO and 1=HI), depending upon what the PC or PLC requires.

Instructions to change the logic output are as follows:

1. Turn the input signal off.
2. Press the FUN button ten times; the display will reflect:

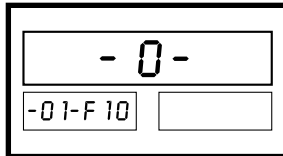

This means that we are in MODE -01-, function 10, which shows that the DOP-BCD is set for negative logic "0" (factory setting).

3. Press any of the lower buttons to toggle the main display between "0" (negative logic) and "1" (positive logic).
4. Press the SET button to store the output logic setting and exit.

MODEL	DOP-BCD	
Output	All NPN OC Transistors (30VDC, 20mA) max.	
Control Functions	HOLD	LO: display updates; receiving equip. receives same data
	ENABLE	LO: all outputs go into a high impedance state
Input Commands	OC NPN	LO: 5mA or more, 0-1.5 VDC level
		HI: Leakage current ≤ 0.1 mA
Decimal Point	Automatic with a range of 10 <sup>-1</sup> to 10 <sup>-4</sup>	
Other Outputs	OVR	LO: When display overflows
	PLUS	LO: When display value is positive
	DT OUT	LO: BCD update occurs
Range	6-digit maximum (999,999)	

The waveforms show that when the ENABLE function is LO, the BCD output data goes to a high impedance state to facilitate the selection of one unique DT-5TXR-BCD unit among several that might be feeding the same PLC. At the same time, when the HOLD function goes LO, the BCD data stop changing, though the display value changes according to the new information fed into the DT-5TX. This provides time for the PLC to catch up (if needed). The BCD data can only change when the update time signal is low.

The table below shows the pin assignments of the 36-pin connector relative to the DOP-BCD.

I/O	DESIGNATION	PIN No.		DESIGNATION	I/O
Output	X 10 <sup>0</sup>	1	1	19	1
		2	2	20	2
		4	3	21	4
		8	4	22	8
	X 10 <sup>1</sup>	1	5	23	1
		2	6	24	2
		4	7	25	4
		8	8	26	8
	X 10 <sup>2</sup>	1	9	27	1
		2	10	28	2
		4	11	29	4
		8	12	30	8
	PLUS	13	31	DP 1	
	DT OUT	14	32	DP 2	
	OVR	15	33	DP 3	
Input	HOLD	16	34	DP 4	
	ENABLE	17	35	GND	
	GND	18	36	GND	

The waveforms below give a synopsis of how the output BCD data behave during the time the different control functions become active.

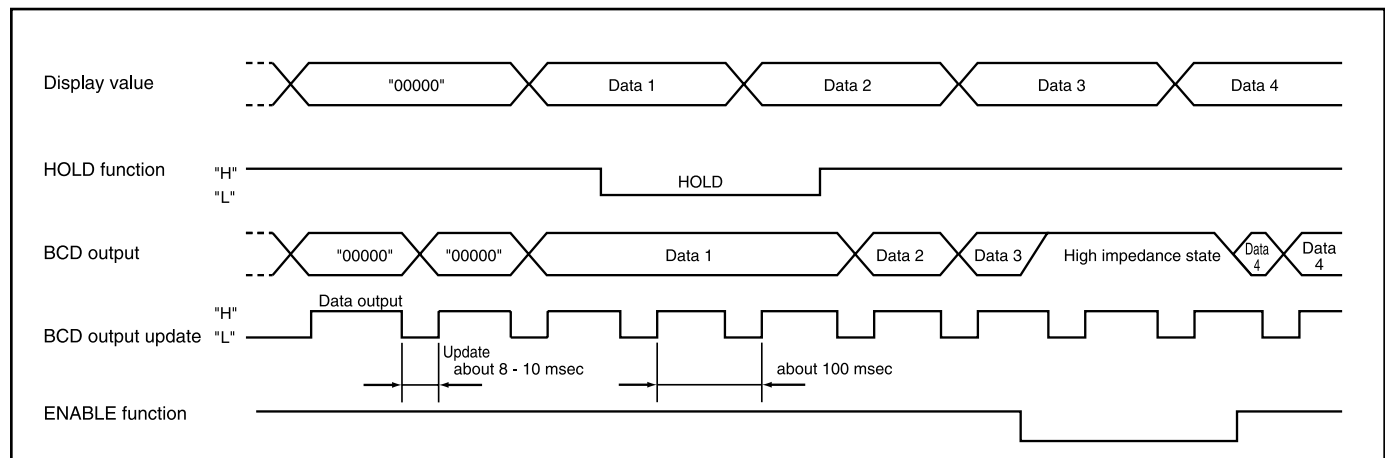

## Dimensions and Specifications

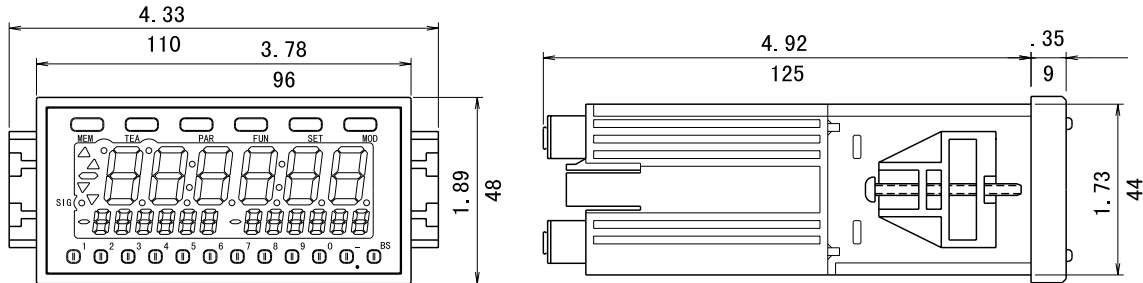

MODEL	DT-5TXR		
Mode	Tachometer / Rate Meter	Elapsed Time	Process Time
Display Range	0 - 999999 with selectable decimal point	0:00:00 - 9:59:59 or 0.00 - 999.99 sec	0:00:00 - 0:59:59 or 0.00 - 999.99 sec
Scalable	Yes (with outputs, see modules)		
Accuracy	± 0.008 % ± 1 digit		± 0.1 % ± 1 digit
Display Update Time	0.2, 0.5, 1, 2, 5, 10, 15, 30, 60 seconds (selectable)		
Time Base	Controlled by a 16.000 MHz crystal		
Display	6 digit 0.59" (15 mm) high LED (main), 2-6 digit 0.02" (6.5 mm) high (secondary)		
Input No. of P/R	1 - 9,999 (programmable)		
Input Signal Characteristics	NPN open collector input : max. frequency 100 kHz Contact input : max. frequency 20 Hz Square wave input : max. frequency 30 kHz Sine wave input (magnetic pickup) : max. frequency 10 kHz		
Sensor Power Supply	12 VDC (150 mA)		
Voltage Requirement	85 - 264 VAC (50/60 Hz) (9 - 35 VDC at 1 W also available)		
Ambient Temperature	32° - 113° F (0 - 45° C)		
Weight	0.66 lb (300 g)		
Dimensions	5.27" L x 3.78" W x 1.89" H (134 mm x 96 mm x 48 mm)		
Warranty	1 year		
OPTIONAL ACCESSORIES	Sensors, modules		

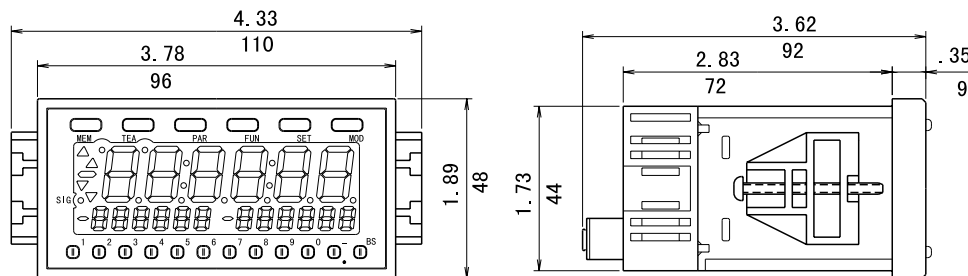

MODEL	DT-5TS		
Mode	Tachometer / Rate Meter	Elapsed Time	Process Time
Display Range	0 - 999999 with selectable decimal point	0:00:00 - 9:59:59 or 0.00 - 999.99 sec	0:00:00 - 0:59:59 or 0.00 - 999.99 sec
Scalable	Yes (no outputs)		
Accuracy	± 0.008 % ± 1 digit		± 0.1 % ± 1 digit
Display Update Time	0.2, 0.5, 1, 2, 5, 10, 15, 30, 60 seconds (selectable)		
Time Base	Controlled by a 16.000 MHz crystal		
Display	6 digit 0.59" (15 mm) high LED (main), 2-6 digit 0.02" (6.5 mm) high (secondary)		
Input No. of P/R	1 - 9,999 (programmable)		
Input Signal Characteristics	NPN open collector input : max. frequency 100 kHz Contact input : max. frequency 20 Hz Square wave input : max. frequency 30 kHz Sine wave input (magnetic pickup) : max. frequency 10 kHz		
Sensor Power Supply	12 VDC (150 mA)		
Voltage Requirement	85 - 264 VAC (50/60 Hz) (9 - 35 VDC at 1 W also available)		
Ambient Temperature	32° - 113° F (0 - 45° C)		
Weight	0.5 lb (234 g)		
Dimensions	3.62" L x 3.78" W x 1.89" H (92 mm x 96 mm x 48 mm)		
Warranty	1 year		
OPTIONAL ACCESSORIES	Sensors		

## Troubleshooting

The following are general checkpoints; please call your local Shimpo representative or contact Shimpo Instruments directly for further assistance.

If display is blank:

- Check all connections: power source (AC type: 85-264VAC 50/60Hz; DC type: 9-35VDC), power cord and wires (**NOTE:** For DC applications confirm that correct voltage polarity is used)

Error codes are displayed:

- Turn power OFF and then ON
- If error code remains, see table below

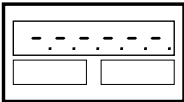
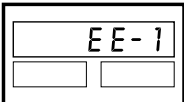
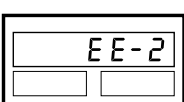
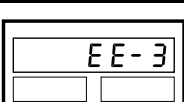
DISPLAY	CONDITION	ACTION
	Overflow of display (when display value is over the limit of display)	Change parameter settings or input signal
	Input signal width is under 10 msec in MODE 3	Change the input signal width
	Beyond the limit of TEA function	Decrease the input RPM
	EE PROM reading error	Press SET key

## Warranty

### LIMITED EXPRESS WARRANTY

Shimpo Instruments warrants, to the original purchaser of new products only, that this product shall be free from defects in workmanship and materials under normal use and proper maintenance for one year from the date of original purchase. This warranty shall not be effective if the product has been subject to overload, misuse, negligence, or accident, or if the product has been repaired or altered outside of Shimpo Instruments's authorized control in any respect which in Shimpo Instruments's judgment, adversely affects its condition or operation.

### DISCLAIMER OF ALL OTHER WARRANTIES

The foregoing warranty constitutes the SOLE AND EXCLUSIVE WARRANTY, and Shimpo Instruments hereby disclaims all other warranties, expressed, statutory or implied, applicable to the product, including, but not limited to all implied warranties of merchantability and fitness.

### LIMITATION OF REMEDY

Under this warranty, Shimpo Instruments' SOLE OBLIGATION SHALL BE TO REPAIR OR REPLACE the defective product or part, at Shimpo Instruments' option. Shimpo Instruments reserves the right to satisfy warranty obligation in full by reimbursing Buyer for all payments made to Shimpo Instruments, whereupon, title shall pass to Shimpo Instruments upon acceptance of return goods. To obtain warranty service, Purchaser must obtain Shimpo Instruments's authorization before returning the product, properly repackaged, freight pre-paid to Shimpo Instruments.

### INDEMNIFICATION & LIMITATION OF DAMAGES

Buyer agrees to indemnify and hold Shimpo Instruments harmless from and against all claims and damages imposed upon or incurred arising, directly or indirectly, from Buyer's failure to perform or satisfy any of the terms described herein. In no event shall Shimpo Instruments be liable for injuries of any nature involving the product, including incidental or consequential damages to person or property, any economic loss or loss of use.

### MERGER CLAUSE

Any statements made by the Seller's representative do not constitute warranties except to the extent that they also appear in writing. This writing constitutes the entire and final expression of the parties' agreement.