

Series **TT02**

TORQUE TOOL TESTERS

User's Guide

Thank you...



Thank you for purchasing a Mark-10 Series TT02 digital torque tool tester, designed to measure the torque produced by manual and electric torque tools.

With proper usage, we are confident that you will get many years of great service with this product. Mark-10 instruments are ruggedly built for both laboratory and industrial environments.

This User's Guide provides setup, safety, and operation instructions. Dimensions and specifications are also provided. For additional information or answers to your questions, please do not hesitate to contact us. Our technical support and engineering teams are eager to assist you.

Before use, each person who is to use a Series TT02 digital torque tool tester should be fully trained in appropriate operation and safety procedures.

TABLE OF CONTENTS

OVERVIEW	2
POWER	3
SETUP	4
HOME SCREEN AND CONTROLS	6
OPERATING MODES	8
CHANGING THE UNITS	8
DIGITAL FILTERS	9
SET POINTS	9
DATA MEMORY AND STATISTICS	10
COMMUNICATIONS	12
BREAK DETECTION	15
FIRST / SECOND PEAK	16
CALIBRATION	18
PASSWORDS	22
OTHER SETTINGS	23
SPECIFICATIONS	25

1 OVERVIEW

1.1 List of included items

Qty.	Part No.	Description
1	MTT02-12 / MTT02-50 / MTT02-100	Series TT02 digital torque tool tester
1	08-1026	Battery (inside the instrument)
1	-	Certificate of calibration
1	09-1165	USB cable
1	-	Resource CD (USB driver, user's guides, MESUR™ Lite software, MESUR™ gauge DEMO software, User's Guide)
1	ST001	Bench mounting kit (optional)
1	ST002	Carrying case (optional)
1	AC1026-1	Rundown fixture, 0-50 lbFin (optional)
1	AC1026-2	Rundown fixture, 50-100 lbFin (optional)

1.2 Safety / Proper Usage

Caution!

Note the torque tester's capacity before use and ensure that the capacity is not exceeded. Producing a torque greater than 150% of the tester's capacity can damage the internal sensor. An overload can occur whether the tester is powered on or off.

The tester is designed primarily for the testing of torque tools, although other items can be tested as well. Items that should not be used with the tester include potentially flammable substances or products, items that can shatter in an unsafe manner, and any other components that can present an exceedingly hazardous situation when acted upon by a load.

The following safety checks and procedures should be performed before and during operation:

1. Never operate the tester if there is any visible damage to the AC adapter or the tester itself.
2. Ensure that the tester is kept away from water or any other electrically conductive liquids at all times.
3. The tester should be serviced by a trained technician only. AC power must be disconnected and the tester must be powered off before the housing is opened.
4. Always consider the characteristics of the sample being tested before initiating a test. A risk assessment should be carried out beforehand to ensure that all safety measures have been addressed and implemented.
5. Wear eye and face protection when testing, especially when testing brittle samples that have the potential to shatter under force. Be aware of the dangers posed by potential energy that can accumulate in the sample during testing. Extra bodily protection should be worn if a destructive failure of a test sample is possible.
6. In certain applications, such as the testing of brittle samples that can shatter, or other applications that could lead to a hazardous situation, it is strongly recommended that a machine guarding system be employed to protect the operator and others in the vicinity from shards or debris.
7. When the tester is not in use, ensure that the power is turned off.

2 POWER

The TT02 is powered either by an 8.4V NiMH rechargeable battery or by an AC adapter. Since these batteries are subject to self discharge, it may be necessary to recharge the unit after a prolonged period of storage. Plug the accompanying charger into the AC outlet and insert the charger plug into the receptacle on the tester (refer to the illustration below). The battery will fully charge in approximately 8 hours.

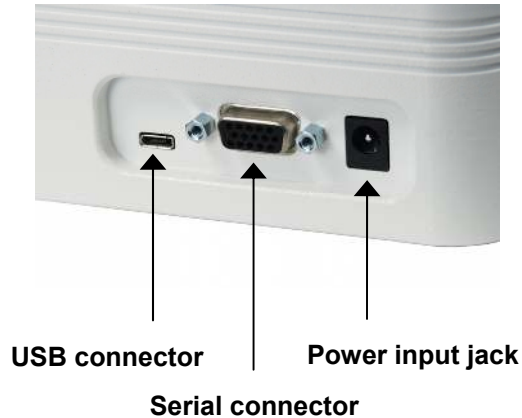





Caution!

Do not use chargers or batteries other than supplied or instrument damage may occur.

If the AC adapter is plugged in, an icon appears in the lower left corner of the display, as follows: 

If the AC adapter is not plugged in, battery power drainage is denoted in a five-step process:

1. When battery life is greater than 75%, the following indicator is present: 
2. When battery life is between 50% and 75%, the following indicator is present: 
3. When battery life is between 25% and 50%, the following indicator is present: 
4. When battery life is less than 25%, the following indicator is present: 
5. When battery life drops to approximately 2%, the indicator from step 4 will be flashing. Several minutes after (timing depends on usage and whether the backlight is turned on or off), a message will appear, "BATTERY VOLTAGE TOO LOW. POWERING OFF". A 4-tone audio indicator will sound and the tester will power off.

The tester can be configured to automatically power off following a period of inactivity. Refer to the **Other Settings** section for details.

If battery replacement is necessary, the battery may be accessed by removing the cover attached to the underside of the base.

3 SETUP

Caution!

Do not use Series TT02 torque testers with pneumatic or impact tools.

3.1 Using manual torque tools

Use a bit adapter of appropriate size and place the tool into the receptacle, as shown in Fig. 1 below. Gradually exert torque by hand until the desired status is achieved (ex. click, slip, etc.).



Fig. 1
Typical manual torque tool test

3.2 Using motorized torque tools

It is highly recommended to use a rundown fixture when testing motorized torque tools, as shown in the illustrations below. Use a bit adapter of appropriate size and place the tool into the rundown fixture, as shown in Fig. 2. Activate the tool until the desired status is achieved (ex. click, slip, etc.). For best performance, the Digital Filter should be configured to its lowest possible setting. Refer to the **Digital Filters** section for details.



Fig. 2
Proper use of a rundown fixture with a motorized torque tool. Note the axial vertical alignment.



Fig. 3
AC1026-1 rundown fixture,
for 0-50 lbFin [0-5.6 Nm]



Fig. 4
AC1026-2 rundown fixture,
for 50-100 lbFin [5.6-11.3 Nm]

3.3 Proper alignment

Align the tool axially with respect to the square drive in the receptacle. Side loading or off-center loading may produce erroneous readings, and can damage the instrument.

Note: It is normal to detect a small amount of mechanical play in the receptacle.

3.4 Mounting to a bench

The tester can be mounted to a bench for horizontal or other orientations using the optional bench mounting kit, as shown below:



4 HOME SCREEN AND CONTROLS

4.1 Home Screen

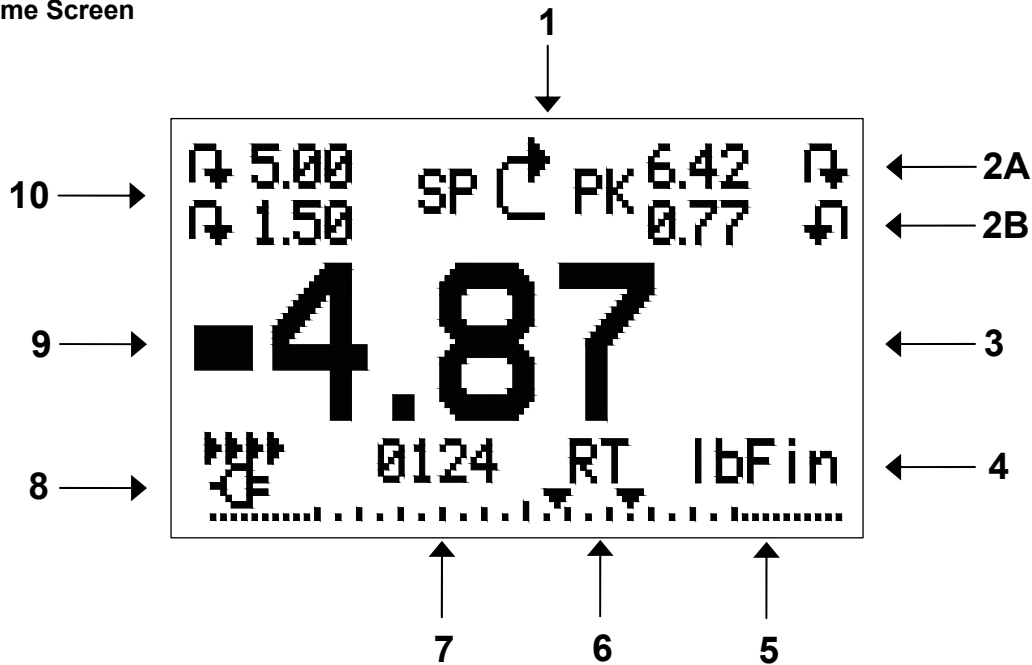

No.	Name	Description
1	Measurement direction indicator	<ul style="list-style-type: none"> ↻ – indicates clockwise direction ↺ – indicates counter-clockwise direction These indicators are used throughout the display and menu.
2A, 2B	Peaks	The maximum measured clockwise and counter-clockwise readings. 2A and 2B refer to First and Second peaks, respectively, when the tester is in First / Second Peak mode (see First/Second Peak section for details). In either mode, press ZERO or power off to reset these values.
3	Primary reading	The current displayed torque reading. See Operating Modes section for details.
4	Units	The current measurement unit. Abbreviations are as follows: ozFin – Ounce-inch lbFin – Pound-inch lbFft – Pound-foot Ncm – Newton-centimeter Nm – Newton-meter
5	Load bar	Analog indicator to identify when an overload condition is imminent. The bar increases either to the right or left from the midpoint of the graph. Increasing to the right indicates clockwise torque, increasing to the left indicates counter-clockwise torque. If set points are enabled, triangular markers are displayed for visual convenience. This indicator reflects the actual torque, which may not correspond to the primary reading (depends on operating mode). The ZERO key does not reset the load bar. See Operating Modes section for details.
6	Mode	The current measurement mode. Abbreviations are as follows: RT – Real Time PCW – Peak Clockwise PCCW – Peak Counter-clockwise 2PK – First / Second Peak BRK – Break Detection

		See Operating Modes section for details about each of these modes
7	Number of stored data points	The number of stored data points in memory, up to 1,000. Displayed only if Memory Storage is enabled for the DATA key.
8	Battery / AC adapter indicator	Either the AC adapter icon or battery power icon will be shown, depending on power conditions. Refer to the Power section for details.
9	High / low limit indicators	Correspond to the programmed set points. Indicator definitions are as follows: ▲ – the primary reading is greater than the upper torque limit ■ – the primary reading is between the torque limits ▼ – the primary reading is less than the lower torque limit
10	Set points	The programmed torque limit values. Typically used for pass/fail type testing. One, two, or no indicators may be present, depending on the configuration shown in the Set Points menu item.

4.2 Controls

Primary Label	Primary Function	Secondary Label	Secondary Function
	Powers the tester on and off. Press briefly to power on, press and hold to power off. Active only when the home screen is displayed.	ENTER	Various uses, as described in the following sections.
ZERO	Zeroes the primary reading and peaks.	▲ (UP)	Navigates up through the menu and sub-menus.
MENU	Accesses the main menu.	ESCAPE	Reverts one step backwards through the menu hierarchy.
MODE	Toggles between measurement modes.	▼ (DOWN)	Navigates down through the menu and sub-menus.
DATA	Stores a value to memory and/or transmits the current reading to an external device, depending on configuration.	DIRECTION	Toggles between clockwise and counter-clockwise directions while configuring set points and other menu functions.

Note: Measurement units are configured through the menu. Refer to the **Changing The Units** section for details.

4.3 Menu navigation basics

Most of the tester's various functions and parameters are configured through the main menu. To access the menu press **MENU**. Use the **UP** and **DOWN** keys to scroll through the items. The current selection is denoted with clear text over a dark background. Press **ENTER** to select a menu item, then use **UP** and **DOWN** again to scroll through the sub-menus. Press **ENTER** again to select the sub-menu item.

For parameters that may be either selected or deselected, press **ENTER** to toggle between selecting and deselecting. An asterisk (*) to the left of the parameter label is used to indicate when the parameter has been selected.

For parameters requiring the input of a numerical value, use the **UP** and **DOWN** keys to increment or decrement the value. Press and hold either key to auto-increment at a gradually increasing rate. When the desired value has been reached, press **ENTER** to save the change and revert back to the sub-menu item, or press **ESCAPE** to revert back to the sub-menu item without saving. Press **ESCAPE** to revert one step back in the menu hierarchy until back into normal operating mode.

Refer to the following sections for details about setting up particular functions and parameters.

5 OPERATING MODES

Caution!

In any operating mode, if the capacity of the instrument has been exceeded by more than 110%, the display will show "OVER" to indicate an overload. A continuous audible tone will be sounded (if beeps are enabled) until the MENU key has been pressed or the torque has been reduced to a safe level).

Five operating modes are possible with the TT02 torque tester. To cycle between the modes, press **MODE** while in the home screen.

5.1 Real time (RT)

The primary reading corresponds to the live measured reading.

5.2 Peak Clockwise (PCW)

The primary reading corresponds to the peak clockwise reading observed. If the actual torque decreases from the peak value, the peak will still be retained in the primary reading area of the display. Pressing **ZERO** will reset the value.

5.3 Peak Counter-clockwise (PCCW)

Same as above, for counter-clockwise readings.

5.4 First / Second Peak (2PK)

Displays first and second peaks for the same measurement direction. This function is used to identify the true peak before tool rotation reaches a hard stop, causing an artificial spike in torque. This mode will only appear if enabled in the **First / Second Peak** menu.

5.5 Break Detection (BRK)

Arms the tester for automatic data output, automatic zero, and/or automatic data storage upon tool slip or click, as configured in the **Break Detection** menu. This mode will only appear if enabled in the **Break Detection** menu.

6 CHANGING THE UNITS

The TT02 can display five different measurement units. To change the unit, select **Units** from the menu. The display will list the available units, as follows:

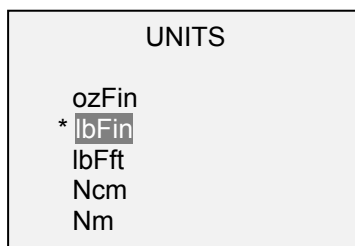

The tester will always power on with the unit selected in this sub-menu.

7 DIGITAL FILTERS

Digital filters are provided to help smooth out the readings in situations where there is mechanical interference in the work area or test sample. These filters utilize the moving average technique in which consecutive readings are pushed through a buffer and the displayed reading is the average of the buffer contents. By varying the length of the buffer, a variable smoothing effect can be achieved. The selection of 1 will disable the filter since the average of a single value is the value itself.

To access digital filter settings, select **Filters** from the menu. The display will appear as follows:

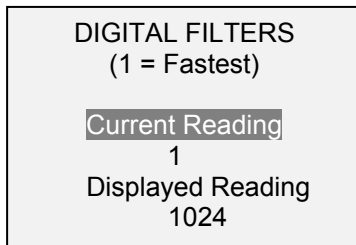

Two filters are available:

Current Reading – Applies to the peak capture rate of the instrument.

Displayed Reading – Applies to the primary reading on the display.

Available settings: 1, 2, 4, 8, 16, 32, 64, 128, 256, 512, 1024.

Note: It is recommended to keep the current reading filter at its lowest value for best performance, and the displayed reading filter at its highest value for best stability.

8 SET POINTS

8.1 General Information

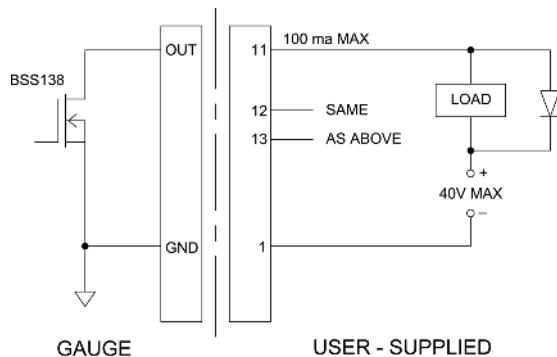

Set points are useful for tolerance checking (pass/fail) and triggering an external device in process control applications. Two limits, high and low, are programmed in the tester, and the primary reading is compared to these limits. The results of the comparisons are indicated via on-screen indicators as well as through the three outputs provided on the 15-pin connector, thus providing “under”, “in range”, and “over” signaling. These outputs can be connected to indicators, buzzers, or relays as required for the application. On-screen indicators are described in the next sub-section.

8.2 Configuration

To configure set points, select **Set Points** from the menu. The screen will appear as follows:

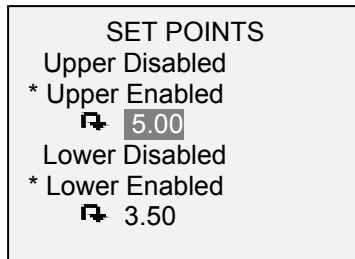

Either one, two, or none of the set points may be enabled. To toggle between the clockwise and counter-clockwise directions, press the **DIRECTION** key.

If two set points have been enabled, they are displayed in the upper left corner of the display. If only one set point has been enabled, the word "OFF" will appear in place of the value. If no set points have been enabled, the upper left corner of the display will be blank.

8.3 Set Point Indicators

When set points are enabled, the following indicators are shown to the left of the primary reading:

- ▲ – the displayed value is greater than the upper load limit (NO GO HIGH)
- – the displayed value is between the limits (GO)
- ▼ – the displayed value is less than the lower torque limit (NO GO LOW)

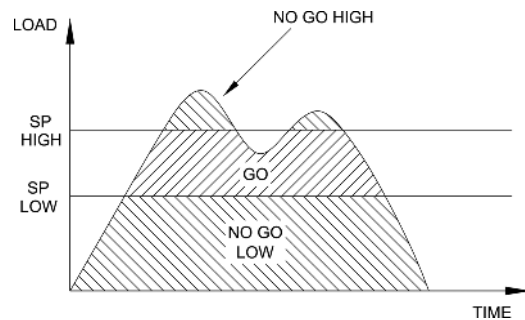

Note: Set point indicators reference the displayed reading, not necessarily the current live torque.

9 DATA MEMORY AND STATISTICS

Series TT02 testers have storage capacity of 1,000 data points. Readings may be stored, viewed, and output to an external device. Individual, or all, data points may be deleted. Statistics are calculated for the data presently in memory.

Individual data points may be saved to memory by pressing the **DATA** key, or automatically via the **Break Detection** or **First / Second Peak** functions, whichever is enabled. Refer to the **Break Detection** and **First / Second Peak** sections for details. Once data storage has been enabled, the data record number **0000** will appear below the primary reading in the home screen. The record number will increment each time **DATA** is pressed or the automatic data storage function is activated. When memory is full the message "MEMORY FULL" will be flashed at the bottom of the display and a double audio tone will be sounded, if beeps are enabled.

To view, edit, and output stored readings and statistics, select **Memory** from the menu. The screen appears as follows:

MEMORY	
View Data	
View Statistics	
Output Data	
Output Statistics	
Output Data & Stats	
Clear All Data	

9.1 View Data

All the saved data points may be viewed. The record number is displayed, along with the corresponding value and presently set unit of measurement. Any readings may be deleted individually. To do so, scroll to the desired reading and press **DELETE**. The letter “D” will appear to the left of the record number, indicating that the tester is in **Delete** mode, as follows:

0001	2.458 lbFin
0002	2.224 lbFin
0003	2.446 lbFin
0004	1.890 lbFin
D 0005	2.098 lbFin
0006	1.998 lbFin
0007	2.042 lbFin

Press **ENTER** to delete the value. To exit **Delete** mode, press **DELETE** again. Any number of readings may be individually deleted, however, all readings may also be cleared simultaneously. Refer to the **Clear All Data** sub-section for details.

9.2 Statistics

Statistical calculations are performed for the saved values. Calculations include number of readings, minimum, maximum, mean, and standard deviation.

9.3 Output Data

Press **ENTER** to output data to an external device. The display will show, “SENDING DATA...”, then “DATA SENT”. If there was a problem with communication, the display will show, “DATA NOT SENT”. Saved data can be downloaded by some Mark-10 data collection programs. Refer to their respective user's guides for details.

9.4 Output Statistics

Press **ENTER** to output statistics to an external device. The display will show, “SENDING STATS...”, then “STATS SENT”. If there was a problem with communication, the display will show, “STATS NOT SENT”.

9.5 Output Data & Stats

Press **ENTER** to output data and statistics to an external device. The display will show, “SENDING DATA”, then “SENDING STATS...”, then “DATA SENT”, then “STATS SENT”. If there was a problem with communication, the display will show, “DATA NOT SENT” and/or “STATS NOT SENT”.

9.6 Clear All Data

Press **ENTER** to clear all data from the memory. A prompt will be shown, “CLEAR ALL DATA?”. Select **Yes** to clear all the data, or **No** to return to the sub-menu.

For output of data and/or statistics, RS-232 or USB output must be enabled. Data formatting is <CR><LF> following each value. Units can be either included or excluded. Output of data via the Mitutoyo output is possible, however, output of statistics is not. Refer to the **Communications** section for details.

Note: Data is not retained while the tester is powered off. However, the tester protects against accidental or automatic power-off. If manually powering the instrument off, or if the inactivity time limit for the **Automatic Shutoff** function has been reached, the following warning message will appear:



If no option is selected, this screen will be displayed indefinitely, or until battery power has been depleted.

10 COMMUNICATIONS

Communication with the TT02 tester is achieved through the micro USB or 15-pin serial ports located in the rear of the housing, as shown in the illustration in the **Power** section. Communication is possible only when the tester is in the main operating screen (i.e. not in a menu or configuration area).

10.1 Installing the USB driver

Caution!

It is recommended that the USB driver be installed before physically connecting the tester to the PC with a USB cable.

For installation instructions, refer to the **Mark-10 USB Driver user's guide**, supplied on the Resource CD or downloadable from www.mark-10.com.

10.2 Serial / USB

To set up RS-232 and USB communication, select **Serial/USB Settings** from the menu. The screen appears as follows:

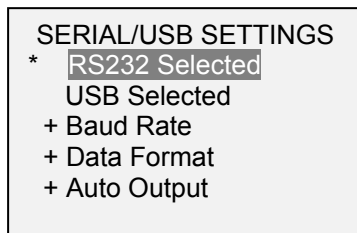

Select either RS-232 or USB input (output is always simultaneous through both the USB and RS-232 ports). Communication settings are permanently set to the following:

Data Bits: 8
Stop Bits: 1
Parity: None

Other settings are configured as follows:

10.2.1 Baud Rate

Select the baud rate as required for the application. It must be set to the same value as the receiving device.

10.2.2 Data Format

Select the desired data format. The screen appears as follows:

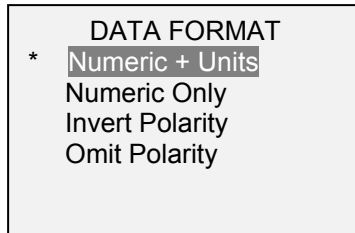

Selection	Description
Numeric + Units	Output format includes the value and unit of measure. Clockwise values have positive polarity, counter-clockwise values have negative polarity.
Numeric Only	Output format includes the value only. Polarity same as above.
Invert Polarity	Clockwise values have negative polarity, counter-clockwise values have positive polarity. May be selected in addition to the Numeric + Units / Numeric Only selection.
Omit Polarity	Both directions are formatted with positive polarity. May be selected in addition to the Numeric + Units / Numeric Only selection.

10.2.3 Data Communication

Individual data points may be transmitted by pressing **DATA**. Series TT02 testers will also respond to the following ASCII commands:

?	Request the displayed reading
MEM	Transmit all stored readings
STA	Transmit statistics

All commands must be terminated with a Carriage Return character or with a Carriage Return/Line Feed combination. The tester's responses are always terminated with a Carriage Return/Line Feed.

Any detected errors are reported back by means of error code *10 (illegal command).

10.3 Mitutoyo BCD settings

This output is useful for connection to data collectors, printers, multiplexers, or any other device capable of accepting Mitutoyo BCD data. Individual data points may be transmitted by pressing **DATA** or by requesting it from the Mitutoyo communication device (if available). Automatic output of individual data points is also possible. Refer to the **Break Detection** and **First / Second Peak** sections for details. To enable Mitutoyo output, select the desired format – either with polarity or without polarity. The screen appears as follows:

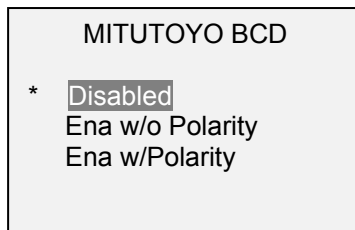

10.4 Analog Output

This output can be used for chart recorders, oscilloscopes, data acquisition systems, or any other compatible devices with analog inputs. The output produces ± 1 volt at full scale of the instrument. The polarity of the signal is positive for clockwise and negative for counter-clockwise.

10.5 DATA Key Settings

To configure the functions of the **DATA** key, select **DATA Key** from the menu. The display will appear as follows:

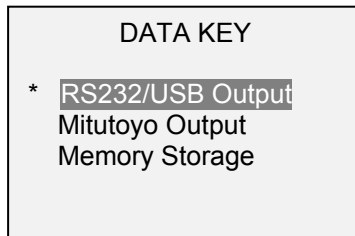

RS232/USB Output	Outputs data via the serial and USB ports
Mitutoyo Output	Outputs data via Mitutoyo (Digimatic) through the serial port
Memory Storage	Stores a reading to memory (refer to the Memory section for details)

Any combination of the above functions may be selected.

10.6 I/O Connector Pin Diagram (female)

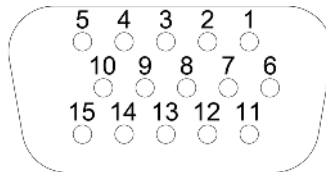

DB-9HD-15

Pin No.	Description	Input / Output
1	Signal Ground	---
2	Counter-clockwise Overload	Output
3	RS-232 Receive	Input
4	RS-232 Transmit	Output
5	+12V DC	Output
6	Analog Output	Output
7	Clockwise Overload	Output
8	Mitutoyo Clock Output Bit 2	Output
9	Mitutoyo Data Output Bit 0	Output
10	Mitutoyo Request Input Bit 3	Input
11 *	Set Point Pin 1 (active) *	Output
12 *	Set Point Pin 2 (active) *	Output
13 *	Set Point Pin 3 (inactive) *	Output
14	Do not connect	---
15	Mitutoyo Ready Output Bit 1	Output

* **Note:** The output assignments for pins 11 and 12 depend on several factors. Refer to the table below for details:

Torque	Pin function			
	Both set points are CW	Both set points are CCW	CW upper set point, CCW lower set point	CCW upper set point, CW lower set point
CW torque greater than lower set point	N/A	Pin 11 active	N/A	Pin 11 active
CW torque greater than upper set point	Pin 11 active	N/A	Pin 12 active	N/A
CCW torque greater than lower set point	Pin 12 active	N/A	Pin 11 active	N/A
CCW torque greater than upper set point	N/A	Pin 12 active	N/A	Pin 12 active

Pin 13 is active when pins 11 and 12 are inactive.

11 BREAK DETECTION

11.1 Configuration

Three functions can be triggered automatically upon tool slip or click (break detection), defined as a 50% drop in torque from the peak:

1. Transmit the peak reading
2. Save the peak value to memory
3. Zero the primary and peak readings

These automatic functions can help automate and expedite testing processes. If beeps are enabled, an audible tone will sound when the output, storage, and zero functions have occurred. In order for break detection to be active, the appropriate operating mode must be selected. See the **Operating Modes** section for details. The display will appear as follows:

BREAK DETECTION	
*	Enabled
+	Break Settings
+	Auto Output
*	Auto Storage
*	Auto Zero

Any combination of the above functions may be selected.

Function	Description
Enabled	If enabled, BRK will appear as one of the operating modes.
Break Settings	Press ENTER to access the Break Detection Settings sub-menu. See Section 10.4.1 for details.
Auto Output	Press ENTER to access the Auto Output Settings sub-menu. See Section 10.4.2 for details.
Auto Storage	Automatically stores the peak reading to memory.
Auto Zero	Automatically zeroes the display following data transmission and/or storage.

11.2 Settings

Set up the trigger for auto output and storage, and the delay to zero the primary and peak readings. The display will appear as follows:

BREAK DETECTION SETTINGS	
Trig. Threshold	5 %
Auto Zero Delay	3 sec.

Trig. Threshold	Sets the percentage of full scale at which the break detection feature becomes active. This threshold is provided to ignore peaks that can occur during sample loading and unloading. Available settings: 5-50%, in 5% increments.
Auto Zero Delay	Sets the time delay before the primary and peak readings are zeroed. Available settings: 1-60 sec., in 1 sec. increments between 1-5 sec., and in 5 sec. increments between 5-60 sec.

11.3 Auto Output Settings

Select the output type. One, both, or no output types may be enabled. The display will appear as follows:

AUTO OUTPUT SETTINGS	
<input checked="" type="checkbox"/>	RS232/USB Output
<input type="checkbox"/>	Mitutoyo Output

Note: The same auto save/output/zero functions are available in **First / Second Peak** mode. Refer to the **First / Second Peak** section for details.

12 FIRST / SECOND PEAK

This function is designed to accurately capture the true peak torque a tool generates at slip or click (first peak), before a mechanical stop causes an artificial spike in torque (second peak).

12.1 Configuration

Several functions can be triggered automatically upon first and second peaks:

1. Transmit the first peak reading
2. Transmit the second peak reading
3. Save the first peak value to memory
4. Save the second peak value to memory
5. Zero the primary and peak readings

These automatic functions can help automate and expedite testing processes. If beeps are enabled, an audible tone will sound when the output, storage, and zero functions have occurred. In order for First / Second Peak detection to be active, the appropriate operating mode must be selected. See the **Operating Modes** section for details. The display will appear as follows:

FIRST/SECOND PEAK
* Enabled
+ Peak Settings
+ Auto Output
* Auto Store PK1
Auto Store PK2
* Auto Zero

Any combination of the above functions may be selected.

Function	Description
Enabled	If enabled, 2PK will appear as one of the operating modes. In the main display, the Peak readings will reference the first and second peaks – first peak on top, second peak below. Refer to the Home Screen & Control section for details.
Peak Settings	Press ENTER to access the Peak Settings sub-menu. See Section 12.2 for details.
Auto Output	Press ENTER to access the Auto Output Settings sub-menu. See Section 12.3 for details.
Auto Store PK1	Automatically stores the first peak reading to memory.
Auto Store PK2	Automatically stores the second peak reading to memory.
Auto Zero	Automatically zeroes the display following data transmission and/or storage.

12.2 Settings

The display will appear as follows:

PEAK SETTINGS	
Thresh. 1:	5 %
% Drop 1:	10 %
Thresh. 2:	5 %
% Drop 2:	10 %
Auto Zero Delay	3 sec.

Threshold 1	Sets the percentage of full scale at which the first/second peak detection feature becomes active. This threshold is provided to ignore peaks that can occur during sample loading and unloading. Available settings: 1-90%, in 1% increments between 1-5%, and in 5% increments between 5-90%.
Percentage Drop 1	Identifies the first peak via detection of a specified percentage drop from peak.
Threshold 2	Same as with Threshold 1, but refers to a percentage of full scale beyond the first peak. For example, for a 50 lbFin capacity tester, if the first peak is 20 lbFin, and Threshold 2 is set to 15%, the threshold is equal to 27.5 lbFin.
Percentage Drop 2	Same as Percentage Drop 1, for the second peak.
Auto Zero Delay	Sets the time delay before the primary and peak readings are zeroed. Available settings: 1-60 sec., in 1 sec. increments between 1-5 sec., and in 5 sec. increments between 5-60 sec.

Thresholds and percentage drops are illustrated below:

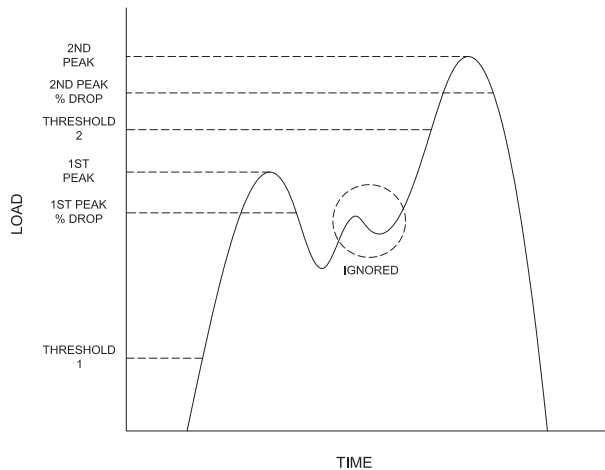

11.3 Auto Output Settings

Select the output type. Select RS-232/USB and/or Mitutoyo outputs, and select First and/or Second peaks. The display will appear as follows:

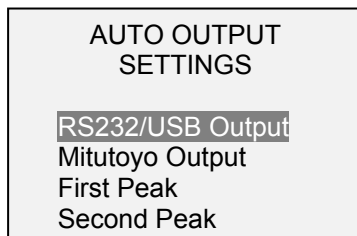

13 CALIBRATION

13.1 Initial Physical Setup

The TT02 should be mounted to a fixture rugged enough to withstand a torque equal to the full capacity of the instrument. Suitable certified calibration equipment is required, and caution should be taken while handling such equipment.

13.2 Calibration Procedure

1. Select **Calibration** from the menu. The display will appear as follows:

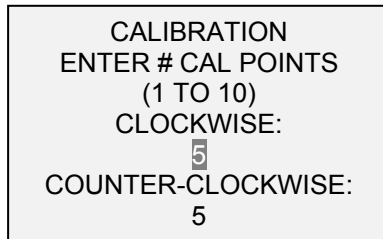

The tester can be calibrated at up to 10 points in each direction. Enter the number of calibration points for each direction. At least one point must be selected for each direction.

Note: To achieve the accuracy specification of $\pm 0.3\%$ of full scale, it is recommended to calibrate the TT02 at 5 or more even intervals in both the clockwise and counter-clockwise directions. For

example, Model MTT02-50 (with capacity of 50 lbFin) should be calibrated at 10, 20, 30, 40, and 50 lbFin loads in each direction.

2. To escape the **Calibration** menu at any time, press **ESCAPE**. The display will appear as follows:

```

CALIBRATION
NOT COMPLETE

CANCEL
EXIT W/O SAVING
  
```

Selecting "CANCEL" will revert back to the Calibration setup. Selecting "EXIT W/O SAVING" will return to the menu without saving changes.

3. After the number of calibration points has been entered, press **ENTER**. The display will appear as follows:

```

CALIBRATION
OFFSET

Place tester
vertical
THEN PRESS ZERO
  
```

4. Place the TT02 in a fixture free from vibration, then press **ZERO**. The tester will calculate offsets, and the display will appear as follows:

```

CALIBRATION
OFFSET

Please wait...
  
```

```

CALIBRATION
OFFSET

Sen.Offset Adj.Passed
Ana.Offset Adj.Passed
  
```

If failed:

```

CALIBRATION
OFFSET

Sen.Offset Adj.Failed
Ana.Offset Adj.Failed
  
```

5. The following screen appears after the offsets have been calculated:

```

CALIBRATION
CLOCKWISE

Attach necessary
weight fixtures.

THEN PRESS ENTER
  
```

Attach weight fixtures (brackets, cable, hook, etc), as required. Do not yet attach any weights or apply any calibration loads. Then press **ENTER**.

6. The display will appear as follows:

```
CALIBRATION
CLOCKWISE

Optionally exercise
load cell a few times.

THEN PRESS ENTER
```

Optionally exercise the internal sensor several times (at full scale, if possible), then press **ENTER**.

7. After displaying "PLEASE WAIT..." the display will appear as follows:

```
CALIBRATION

ENSURE NO LOAD

THEN PRESS ZERO
```

8. The display will appear as follows:

```
CALIBRATION
CLOCKWISE
GAIN ADJUST
APPLY FULL SCALE LOAD
50.000 LBFIN +/-20%
THEN PRESS ENTER
```

Apply torque equal to the full scale of the instrument, then press **ENTER**.

Remove the torque, leave the fixtures in place, then press **ZERO**.

9. The display will appear as follows:

```
CALIBRATION
CLOCKWISE
APPLY LOAD
1 OF 5
ENTER LOAD:
10.000 LBFIN
THEN PRESS ENTER
```

Use the **UP** and **DOWN** keys to adjust the torque value as required. The torque values default to even increments, as indicated by the previously entered number of data points described in Step 1. Then press **ENTER**.

Repeat the above step for the number of data points selected.

10. After all the clockwise calibration points have been completed, the display will appear as follows:

CALIBRATION
CLOCKWISE COMPLETE
REVERSE DIRECTION
FOR CCW
Attach necessary
weight fixtures.
THEN PRESS ENTER

Press **ENTER**.

11. At the completion of the counter-clockwise calibration, the display will appear as follows:

CALIBRATION
COMPLETE
SAVE & EXIT
EXIT W/O SAVING

To save the calibration information, select "SAVE & EXIT". To exit without saving the data select "EXIT W/O SAVING".

12. Any errors are reported by the following screens:

CALIBRATION
Units must be kgFmm.
PLEASE TRY AGAIN
PRESS ENTER

Displayed at the start of calibration if a disallowed unit is selected.

LOAD NOT STABLE
PLEASE TRY AGAIN

Ensure that the load is not swinging, oscillating, or vibrating in any manner. Then try again.

CALIBRATION
CLOCKWISE
LOAD TOO LOW
PLEASE TRY AGAIN

The calibration load does not match the set value.

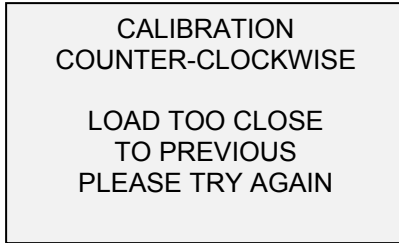

The entered calibration point is too close to the previous point.

14 PASSWORDS

Two separate passwords may be set to control access to the **Calibration** section and to the menu and other keys. To access the passwords setup screen, select **Passwords** from the menu. The display will appear as follows:

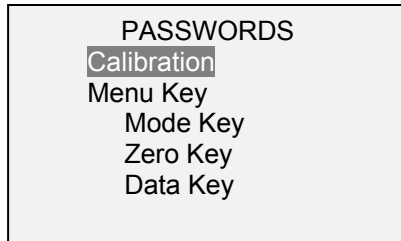

14.1 Calibration Password

Select **Calibration** from the sub-menu. The display will appear as follows:

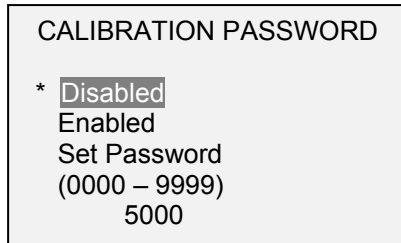

To set the password, select **Enabled**, then **Set Password**. Use the **UP** and **DOWN** keys to increment and decrement the value, from 0 to 9999. When the desired value has been selected, press **ENTER**, then **ESC** to exit the sub-menu.

14.2 Menu Key Password

If enabled, a password must be provided every time the **MENU** key is selected. Select **Menu Key** from the sub-menu. Follow the same procedure as described in the previous sub-section.

14.3 Locking Out Other Keys

Other keys may be locked out individually. Select any combination of keys (**MODE**, **ZERO**, **DATA**) by pressing **ENTER** in the **Passwords** sub-menu. Pressing a locked key will prompt the message "KEY PROTECTED" and then revert to the previous screen.

14.4 Password Prompts

If passwords have been enabled, the following will be displayed when pressing the **MENU** key or accessing the **Calibration** section:

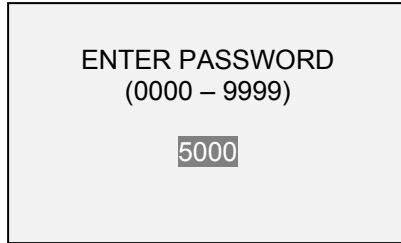

Use the **UP** and **DOWN** keys to select the correct password, then press **ENTER** to continue.

If the incorrect password has been entered, the display will appear as follows:

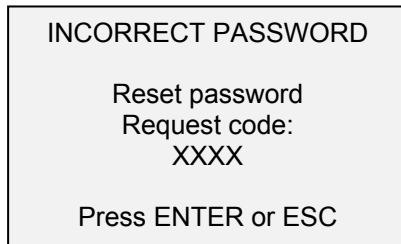

To re-enter the password, press **ESC** to exit to the home screen. Then, access the desired function and enter the password again when prompted.

If the password has been misplaced, it can be reset. Press **ENTER** to generate a *request code*. The *request code* must be supplied to Mark-10 or a distributor, who will then provide a corresponding *activation code*. Enter the *activation code* to disable the password.

15 OTHER SETTINGS

15.1 Automatic Shutoff

The tester may be configured to automatically power off following a period of inactivity while on battery power. Inactivity is defined as the absence of any key presses or load changes of 100 counts or less. To access these settings, select **Automatic Shutoff** from the menu. The display will appear as follows:



Select **Disabled** to disable automatic shutoff. Select **Enabled** to enable it. The length of time of inactivity is programmed in minutes via the **Set Minutes** parameter. Available settings: 5-30, in 5 minute increments.

Note: If the AC adapter is plugged in, the tester will ignore the **Automatic Shutoff** setting and remain powered on until the **POWER** key is pressed.

15.2 Backlight

Several initial settings are available upon powering on the tester. To access these settings, select **Backlight** from the menu. The display will appear as follows:



Select **Off** for the backlight to be off upon powering on the tester.

Select **On** for the backlight to be on upon powering on the tester.

Select **Auto** for the backlight to be on upon powering on the tester, but will shut off after a period of inactivity (as defined in the **Automatic Shutoff** sub-section). The backlight will turn on again when activity resumes. The length of time of inactivity is programmed in minutes via the **Set Minutes** parameter. Available settings: 1-10, in 1 minute increments.

Note: If the AC adapter is plugged in, the tester will ignore these settings and keep the backlight on. Selecting the **On** or **Off** setting in the **Backlight** menu will manually turn the backlight on or off.

15.3 LCD Contrast

The contrast of the display may be adjusted. Select **LCD Contrast** from the menu. The screen will appear as follows:



Press **ENTER** to modify the contrast. Select a value from 0 to 25, with 25 producing the most contrast.

15.4 Beeps

Audible tones can be enabled for all key presses and alerts, such as overload, set point value reached, etc. The Set Point alert can be configured to be either a momentary tone or a continuous tone (until the load is restored to a value between the set points). To configure the functions for which audible tones will apply, select **Beeps** from the menu. The screen will appear as follows:

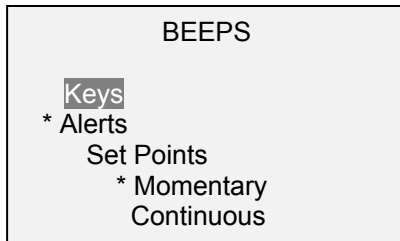

15.5 Initial Settings

The default units and operating mode at power-on may be configured. To access this parameter, select **Initial Settings** from the menu. The screen will display the available modes. An example is as follows:

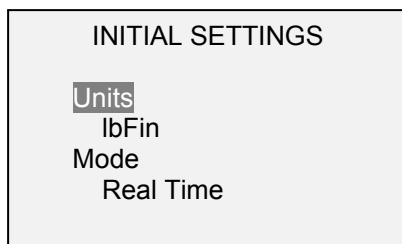

For available units, refer to the **Units** section. For available modes, refer to the **Home Screen And Controls** section.

15.6 Information / Welcome Screen

The following screen is displayed at power-up and can be accessed at any time by selecting **Information** from the menu:

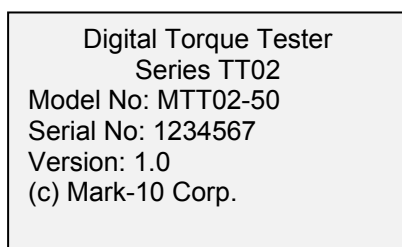

16 SPECIFICATIONS

16.1 General

Accuracy:	±0.3% of full scale
Sampling rate:	7,000 Hz
Power:	AC or rechargeable battery. Low battery indicator appears when battery level is low, and tester powers off automatically when power reaches critical stage.
Battery life:	Backlight on: up to 7 hours of continuous use Backlight off: up to 24 hours of continuous use
Measurement units:	ozFin, lbFin, lbFft, Nm, Ncm
Outputs:	USB / RS-232: Configurable up to 115,200 baud. Mitutoyo (Digimatic): Serial BCD suitable for all Mitutoyo SPC-compatible devices. Analog: ±1 VCD, ±0.25% of full scale at capacity. General purpose: Three open drain outputs, one input. Set points: Three open drain lines.
Configurable settings:	Digital filters, outputs, set points, break detection, first/second peak, automatic shutoff, default units, default mode, passwords, key tones, audio alarms, backlight, calibration
Safe overload:	150% of full scale (display shows "OVER" at 110% and above)
Weight:	5.8 lb [2.6 kg]
Included accessories:	AC adapter, battery, USB cable, resource CD (USB driver, MESUR™ Lite software, MESUR™ gauge DEMO software, and user's guide), NIST-traceable certificate of calibration
Warranty:	3 years (see individual statement for further details)

16.2 Factory Settings

Parameter	Setting
Set points	
Upper	Disabled (defaults to 80% of full scale, clockwise, when enabled)
Lower	Disabled (defaults to 40% of full scale, clockwise, when enabled)
Filters	
Current	1
Displayed	1024
DATA Key Functions	
RS-232/USB Output	Enabled
Mitutoyo Output	Disabled
Memory Storage	Enabled
Backlight	Auto
Minutes	1
Serial/USB	
RS-232 Output Selected	Disabled
USB Output Selected	Enabled
Baud Rate	9,600
Data Format	Numeric + units
Mitutoyo BCD Output	Disabled
Break Detection	Disabled
Automatic Output	
RS-232/USB Output	Disabled
Mitutoyo Output	Disabled
Automatic Storage	Disabled
Automatic Zero	Disabled
Break Detection Settings	
Trigger Threshold	10%
Auto Zero Delay	5 sec.
First / Second Peak	Disabled
Auto Store PK1	Disabled
Auto Store PK2	Disabled
Auto Zero	Disabled
Peak Settings	
Threshold 1	10%
% Drop 1	10%
Threshold 2	10%
% Drop 2	10%
Auto Zero Delay	5 sec.
Auto Output	
RS-232/USB Output	Disabled
Mitutoyo Output	Disabled
First Peak	Disabled
Second Peak	Disabled
Automatic Shutoff	Enabled
Minutes	5
Beeps	
Keys	Enabled
Alerts	Enabled
Set Points	Momentary
LCD Contrast	10
Initial Mode	Real Time
Units	lbFin
Passwords	All passwords disabled

16.3 Capacity x Resolution

Model No.	ozFin	lbFin	lbFft	Ncm	Nm
MTT02-12	192 x 0.1	12 x 0.005	1 x 0.0005	135 x 0.1	1.35 x 0.001
MTT02-50	800 x 0.5	50 x 0.02	4 x 0.002	570 x 0.5	5.7 x 0.005
MTT02-100	1600 x 1	100 x 0.05	8 x 0.005	1150 x 0.5	11.5 x 0.005

16.4 Dimensions
IN [MM]

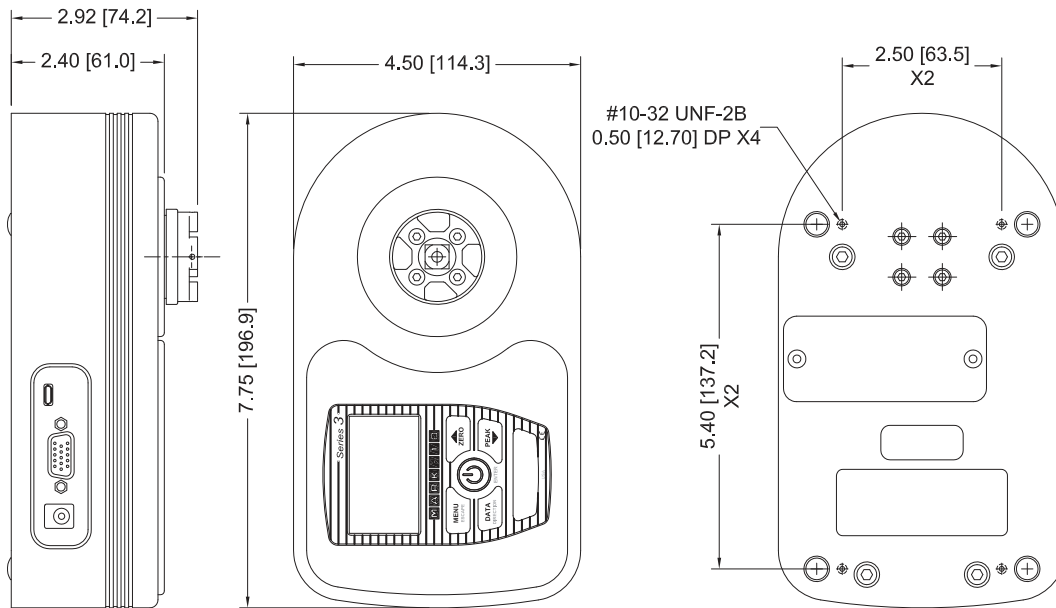

RECEPTACLE TOP VIEW:

